

PROPRIETARY INFO REC. CHARGE CUT OFF: BY CURRENT 50mA OR TIMER 4H change to REC. CHARGE CUT OFF: BY CURRENT 67mA OR TIMER 6H

PROPRIETARY OF GLOBTEK, INC. ANY REPRODUCTION, DISCLOSURE OR USE OF THIS DRAWING, IN WHOLE OR IN PART, IS HEREBY PROHIBITED EXCEPT AS SPECIFIED IN WRITING BY GLOBTEK, INC.

REVISION HISTORY

REV	DESCRIPTION	SALES	RFS	DATE	APPROVED
A	INITIAL RELEASE	DR	FI-137341	11.11.20	DR
B	UPDATE MECHANICAL DWG	JM		3/12/2021	DR
C	Update UN code and capacity to match Samsung cell spec (Changes in Yellow)	JM		3/18/2021	DR
D	CELL: INR18650-35E change to CELL: LR1865HB, CHARGE CURRENT: 0.5C change to CHARGE CURRENT: 0.3C MAX REC. CHARGE CUT OFF: BY CURRENT 50mA OR TIMER 4H change to REC. CHARGE CUT OFF: BY CURRENT 67mA OR TIMER 6H	DR	27637	5/18/2021	DR
E	INTERNAL IMPEDANCE: ≤135 mΩ change to NTERNAL IMPEDANCE: ≤220 mΩ OVER CURRENT DETECTION: 3.5A to 6.5 A (20 to 28msec. DELAY) change to OVER CURRENT DETECTION: 4.0A to 7.0A (8 to 15msec. DELAY)	DR	27643	6/10/2021	DR
F	Update model to BL3500C1865001S1PCMK, charge current to 0.5CMax, update label drawing	DR	27773	2/27/2023	DR
G	Update label and model on title to 1INR19/73	DR		3/21/2023	DR

See Page 2 for important battery warranty and usage information.

Foot Note:

Globtek Inc. will not be liable for the safety and performance of these power supplies if unauthorized access and repair occurs. End user should consult applicable UL, CSA or EN standards for proper installation instruction.

Limitation of Use:

Globtek product are not authorized for use as mission critical components in life support hazardous environment, nuclear or aircraft applications without prior written approval from the CEO of Globtek Inc.

Contents of this document are subject to change without prior notice

 GlobTek® Inc.

www.globtek.com

186 Veterans Drive, Northvale, NJ 07467

Tel. 201-784-1000 Fax 201-784-0111

Drawing Title: Li-Ion Battery Pack, 1S1P, 3350mAh

MODEL NO: 1INR19/73

PART NO: BL3500C1865001S1PCMK

REV G

PROPRIETARY INFORMATION:

PROPRIETARY OF GLOBTEK, INC. ANY REPRODUCTION, DISCLOSURE OR USE OF THIS DRAWING, IN WHOLE OR IN PART, IS HEREBY PROHIBITED EXCEPT AS SPECIFIED IN WRITING BY GLOBTEK, INC.

By customer signing or accepting this document, they agree to acknowledge, accept, AND REGULARLY REVIEW the **Guidelines and cautions, Safety Notes, and Safety Precautions published on GlobTek's website** http://en.globtek.com/safety-cautions.php#.UUD-NRzU_I8

GlobTek offers a 5-year warranty on workmanship and electrical components assembly on all new battery pack products excluding the battery cells themselves which are covered by the Manufacturer's original warranty at their published warranty period. Please refer to the manufacturer's manufacturer's warranty policy for cells. For GlobTek brand cells, GlobTek provides a 12-month warranty for Li-Ion batteries. The warranty period is based upon the expectation that the battery will deliver 80% of its initial capacity after 300 cycles at low to moderate power loads. High power loads may cause a battery to reach 80% of initial capacity in less than the 12-month warranty period. Li-Ion batteries will continue to operate below the 80% capacity threshold; however, the capacity (run time) delivered between charges will continue to decrease.

The purchaser of GlobTek battery pack products (Customer) agrees that they are a "Sophisticated user" who understands battery technology and that it is their sole responsibility to determine suitability of the product described for their application and to take precautions for protection against any hazards attendant to the handling and use of the product. GlobTek products are only designed for professional use and integration by companies into their products and may not be used by consumers directly. GlobTek provides batteries and battery packs as a component of an end system.

The acceptance of GlobTek specifications, the information on this page and use of the product(s) described in this or other GlobTek documents indicate that the product was qualified for use (tested and/or sample waiver signed), and the acceptance and binding of the customer to GlobTek terms and conditions, which supersede all other agreements, terms and conditions (<http://en.globtek.com/terms-and-conditions/>).

Customer Approval of Specification:

Please approve, sign and send back to GlobTek so we can complete order processing.

A delay in receipt of this form will delay delivery schedule.

Company Name:

Customer P/N:

Quote Number:

Date:

Authorized Representative Name:

Authorized Representative Signature:

 GlobTek®, Inc.

www.globtek.com

186 Veterans Drive, Northvale, NJ 07467

Tel. 201-784-1000 Fax 201-784-0111

Drawing Title: Li-Ion Battery Pack, 1S1P, 3350mAh

MODEL NO:1INR19/73

PART NO: BL3500C1865001S1PCMK

REV G

PROPRIETARY INFORMATION:

PROPRIETARY OF GLOBTEK, INC. ANY REPRODUCTION, DISCLOSURE OR USE OF THIS DRAWING, IN WHOLE OR IN PART, IS HEREBY PROHIBITED EXCEPT AS SPECIFIED IN WRITING BY GLOBTEK, INC.

1. GENERAL SPECIFICATION:

BATTERY WITH SAFETY CIRCUIT AND PLASTIC HOUSING

CELL:	LR1865HB
PCM:	GLOBTEK STANDARD
NTC:	N/A
ID:	N/A
CONFIGURATION:	1S1P
WEIGHT:	APROX 45 G

2. ELECTRICAL SPECIFICATION:

RATED CAPACITY:	3350 mAh
NOMINAL VOLTAGE:	3.6
WATT-HOUR RATING:	12.06Wh
CHARGING METHOD:	CONSTANT CURRENT + CONSTANT VOLTAGE
MAX. CHARGE VOLTAGE [V]:	4.2
CHARGE CURRENT:	0.5C MAX
REC. CHARGE CUT OFF:	BY CURRENT 67mA OR TIMER 6H
MAX. CONTINUOUS DISCHARGE CURRENT:	2A
REC. DISCHARGE CUT OFF:	2.8V
INTERNAL IMPEDANCE:	≤220 mΩ
EXP. CYCLE LIFE:	>500 CYCLES > 70% OF INITIAL CAP. (0.5C/0.5C)

CELL PROTECTION:

OVER CHARGE DETECTION:	4.25 ±0.03V (0.8 TO 1.2 SEC. DELAY, RESUME 4.19±0.03V)
OVER DISCHARGE DETECTION:	2.80 ±0.05V (130 to 160msec. DELAY, RESUME 3.0±0.05V)
OVER CURRENT DETECTION:	4.0A to 7.0A (8 to 15msec. DELAY)

3. AMBIENT CONDITIONS

TEMPERATURE RANGE:	
CHARGE:	0 TO +45°C
DISCHARGE:	-10 TO +60°C
CHARGE RETENTION/STORAGE [%]:	1 YEAR AT -20 TO +20°C >80% 3 MONTHS AT -20 TO +45°C >80% 1 MONTH AT -20 To +60°C >80%
HUMIDITY:	60 ±25%RH

4. ENVIRONMENTAL AND SAFETY

PLEASE FOLLOW GlobTek, Inc. HANDLING AND SAFETY PRECAUTIONS FOR Lilon & LiPolymer.

5. CELL REGULATORY APPROVALS:

UL:	UL1642
-----	--------

6. BATTERY PACK APPROVALS:

RoHS:	COMPLIES WITH EU 2002/95/EC AND CHINA SJ/T 11363-2006
CE Mark:	COMPLIES WITH 2013/56/EU EN61000-6-1:2007, EN61000-6-3:2007

TRANSPORTATION:	PACK DESIGNED TO MEET un38.3
UL:	Design to meet UL2054, IEC62133



PROPRIETARY INFORMATION:

PROPRIETARY OF GLOBTEK, INC. ANY REPRODUCTION, DISCLOSURE OR USE OF THIS DRAWING, IN WHOLE OR IN PART, IS HEREBY PROHIBITED EXCEPT AS SPECIFIED IN WRITING BY GLOBTEK, INC.

6. MECHANICAL:

DIMENSIONS:	70.3(mm) x 19(mm) Max.
SHRINK WRAP:	Blue PVC with GlobTek Brand
WIRE TYPE:	UL1571- 28AWG
WIRE LENGTH:	100mm +/- 5.0
WIRE POLARITY:	RED POSITIVE (+)
WIRE POLARITY:	BLACK NEGATIVE (-)
STRIP LENGTH:	CUT BLUNT
TIN LENGTH:	N/A
ADDITIONAL REQUIREMENTS:	N/A

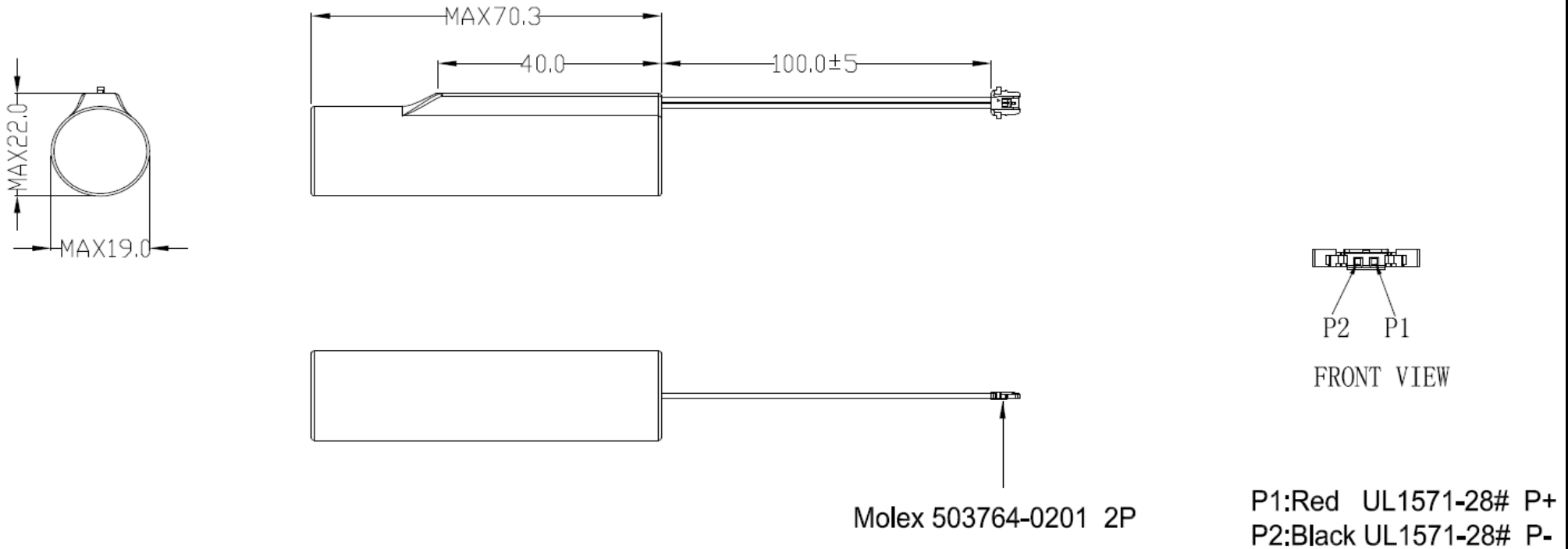

[ADDITIONAL OUTPUT PLUG OPTIONS ARE AVAILABLE BY CLICKING THIS LINK.](#)
[STANDARD PLUGS AND CONNECTORS CAN BE SEEN ONLINE BY CLICKING THIS LINK](#)

GlobTek, Inc.

www.globtek.com

186 Veterans Drive, Northvale, NJ 07467

Tel. 201-784-1000 Fax 201-784-0111

Drawing Title: Li-Ion Battery Pack, 1S1P, 3350mAh

MODEL NO: 11NR19/73

PART NO: BL3500C1865001S1PCMK

REV G

PROPRIETARY INFORMATION:

PROPRIETARY OF GLOBTEK, INC. ANY REPRODUCTION, DISCLOSURE OR USE OF THIS DRAWING, IN WHOLE OR IN PART, IS HEREBY PROHIBITED EXCEPT AS SPECIFIED IN WRITING BY GLOBTEK, INC.

7. OUTPUT CONNECTOR:

ACTUAL CONNECTOR'S, OVERMOLDS, MAY VARY SLIGHTLY FROM THE PICTURE BELOW

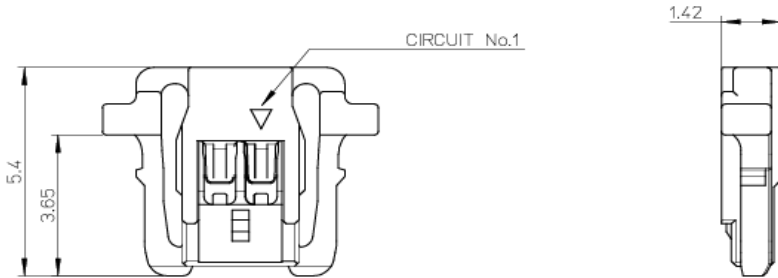
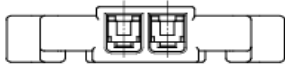

EQUIVALENT	Y / N	
PLUG TYPE	Y	Molex 503764-0201, 2 POS
OVER MOLD ORIENTATION	Y	with overmold
CONTACTS	Y	Molex 503765 (2 req'd)
PIN 1	Y	RED(+)
PIN 2	Y	BLACK(-)
ADDITIONAL REQUIREMENTS		N/A

[ADDITIONAL OUTPUT PLUG OPTIONS ARE AVAILABLE BY CLICKING THIS LINK.](#)
[STANDARD PLUGS AND CONNECTORS CAN BE SEEN ONLINE BY CLICKING THIS](#)

PROPRIETARY INFORMATION:

PROPRIETARY OF GLOBTEK, INC. ANY REPRODUCTION, DISCLOSURE OR USE OF THIS DRAWING, IN WHOLE OR IN PART, IS HEREBY PROHIBITED EXCEPT AS SPECIFIED IN WRITING BY GLOBTEK, INC.

8. LABEL:

MATERIAL:	TBD
BACKGROUND COLOR:	WHITE
TEXT COLOR:	BLACK
LABEL WIDTH: (mm)	45.0 mm
LABEL HEIGHT: (mm)	18.0 mm
ADDITIONAL REQUIREMENTS:	N/A

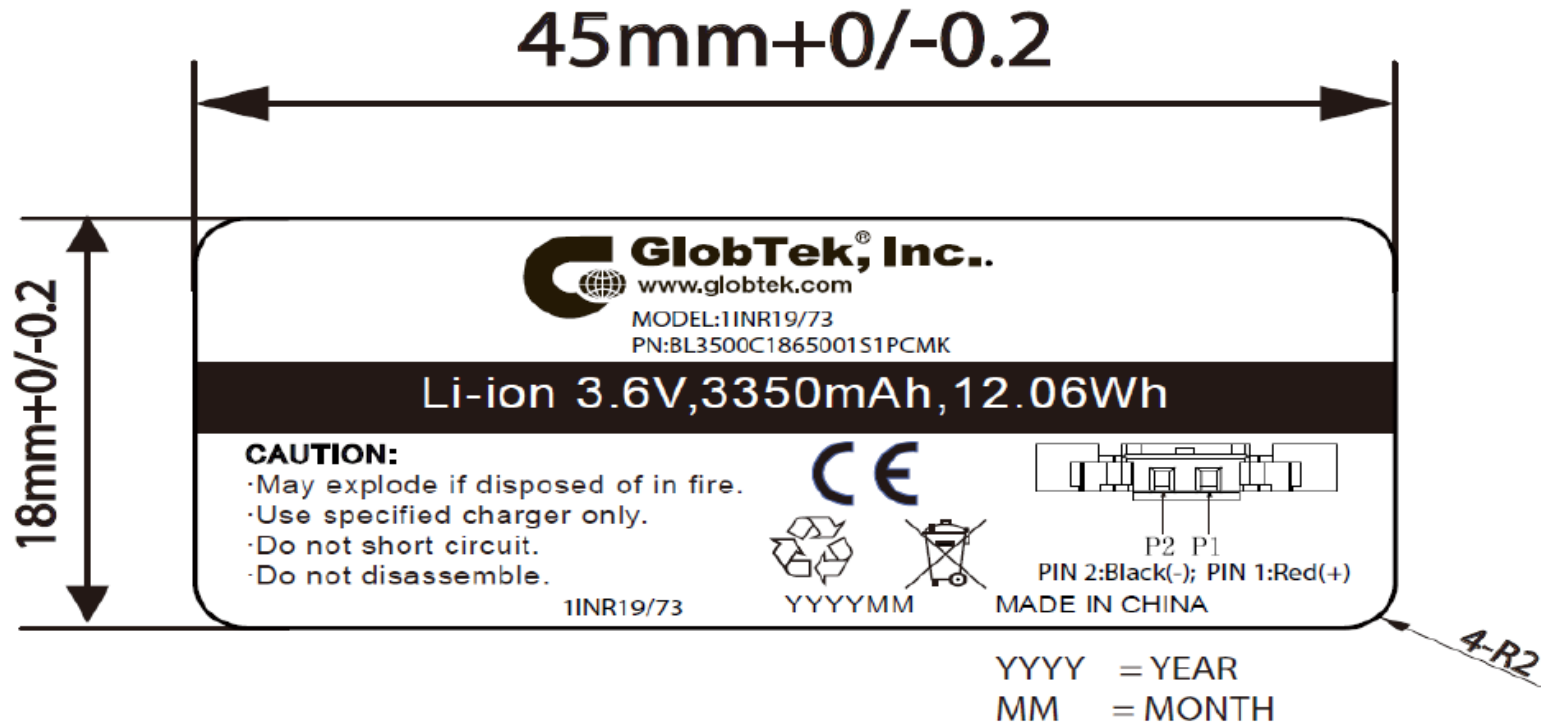

PROPRIETARY INFORMATION:

PROPRIETARY OF GLOBTEK, INC. ANY REPRODUCTION, DISCLOSURE OR USE OF THIS DRAWING, IN WHOLE OR IN PART, IS HEREBY PROHIBITED EXCEPT AS SPECIFIED IN WRITING BY GLOBTEK, INC.

9. PACKAGING:

PE BAG SIZE	120*100mm
CARTON SIZE:	335*375*165mm
QUANTITY PER CARTON:	128pcs
G.W.	TBD

128 PCS/CARTON

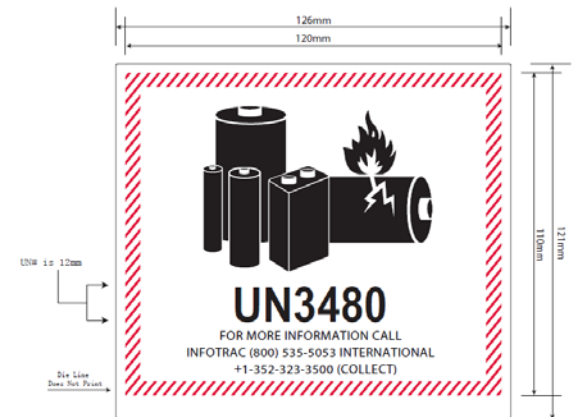
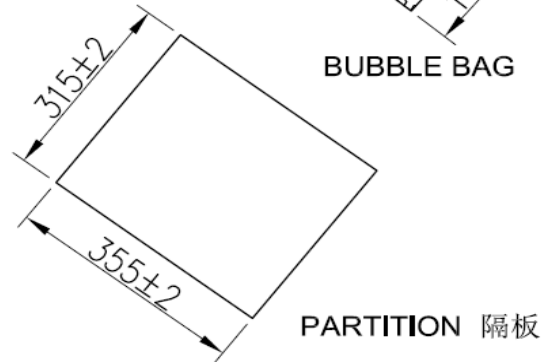
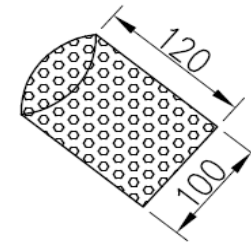
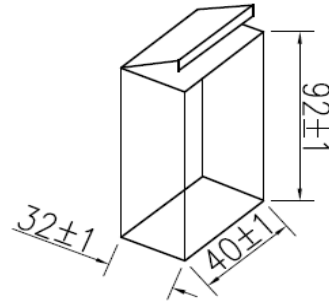
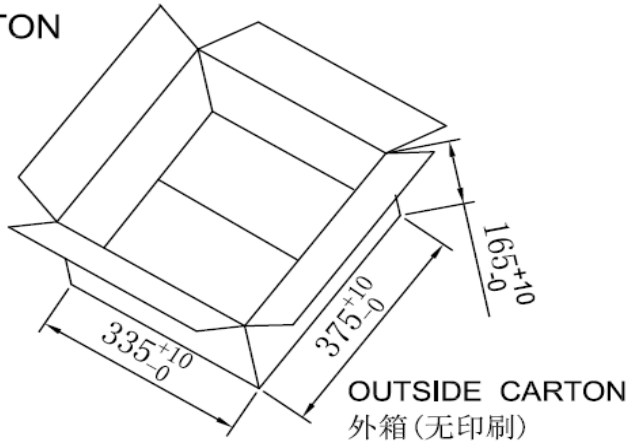

GlobTek, Inc.

www.globtek.com

186 Veterans Drive, Northvale, NJ 07467

Tel. 201-784-1000 Fax 201-784-0111

Drawing Title: Li-Ion Battery Pack, 1S1P, 3350mAh

MODEL NO: 11NR19/73

PART NO: BL3500C1865001S1PCMK

REV G