

# SN74AC16-Q1 Automotive Hex Inverters With Schmitt-Trigger Inputs and Open-Drain Outputs

## 1 Features

- AEC-Q100 qualified for automotive applications:
  - Device temperature grade 1: -40°C to +125°C
  - Device HBM ESD classification level 2
  - Device CDM ESD classification level C4B
- Wide operating range of 1.5V to 6V
- Continuous 24mA output drive at 5V
- Supports up to 75mA output drive at 5V in short bursts
- All inputs and outputs include positive and negative clamp diodes
- Output clamp diodes provide protection for driving inductive loads such as relays
- Maximum  $t_{pd}$  of 7.7ns at 5V, 50pF load

## 2 Applications

- [Control indicator LEDs](#)
- Drive low-voltage relay coils
- Wired-OR with open-drain outputs

## 3 Description

The SN74AC16-Q1 contains six independent inverters with Schmitt-trigger inputs and open-drain outputs.

### Package Information

PART NUMBER	PACKAGE <sup>(1)</sup>	PACKAGE SIZE <sup>(2)</sup>
SN74AC16-Q1	PW (TSSOP, 14)	5mm × 6.4mm

(1) For more information, see [Section 11](#).

(2) The package size (length × width) is a nominal value and includes pins, where applicable.

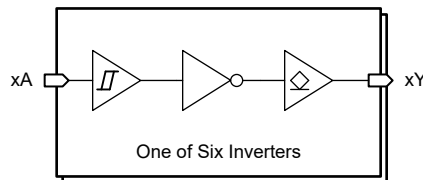

**Logic Diagram (Positive Logic)**



## Table of Contents

<b>1 Features</b> .....	1	7.4 Device Functional Modes.....	10
<b>2 Applications</b> .....	1	<b>8 Application and Implementation</b> .....	11
<b>3 Description</b> .....	1	8.1 Application Information.....	11
<b>4 Pin Configuration and Functions</b> .....	3	8.2 Typical Application.....	11
<b>5 Specifications</b> .....	4	8.3 Power Supply Recommendations.....	13
5.1 Absolute Maximum Ratings.....	4	8.4 Layout.....	13
5.2 ESD Ratings.....	4	<b>9 Device and Documentation Support</b> .....	15
5.3 Recommended Operating Conditions.....	4	9.1 Receiving Notification of Documentation Updates... 15	
5.4 Thermal Information.....	4	9.2 Support Resources.....	15
5.5 Electrical Characteristics.....	5	9.3 Trademarks.....	15
5.6 Switching Characteristics.....	6	9.4 Electrostatic Discharge Caution.....	15
5.7 Typical Characteristics.....	7	9.5 Glossary.....	15
<b>6 Parameter Measurement Information</b> .....	8	<b>10 Revision History</b> .....	15
<b>7 Detailed Description</b> .....	9	<b>11 Mechanical, Packaging, and Orderable Information</b> .....	15
7.1 Overview.....	9	11.1 Tape and Reel Information.....	16
7.2 Functional Block Diagram.....	9	11.2 Mechanical Data.....	18
7.3 Feature Description.....	9		

## 4 Pin Configuration and Functions

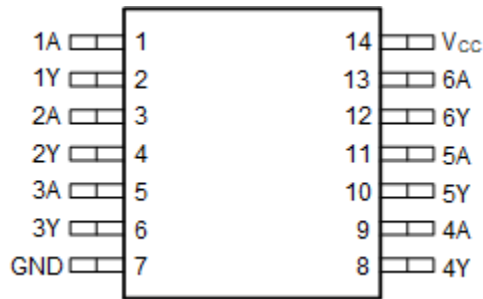

Figure 4-1. SN74AC16-Q1 PW Package, 14-Pin TSSOP (Top View)

Table 4-1. Pin Functions

PIN		TYPE <sup>(1)</sup>	DESCRIPTION
NAME	NO.		
1A	1	I	Channel 1 input
1Y	2	O	Channel 1 output
2A	3	I	Channel 2 input
2Y	4	O	Channel 2 output
3A	5	I	Channel 3 input
3Y	6	O	Channel 3 output
GND	7	G	Ground
4Y	8	O	Channel 4 output
4A	9	I	Channel 4 input
5Y	10	O	Channel 5 output
5A	11	I	Channel 5 input
6Y	12	O	Channel 6 output
6A	13	I	Channel 6 input
V <sub>CC</sub>	14	P	Positive supply

(1) Signal Types: I = Input, O = Output, I/O = Input or Output

## 5 Specifications

### 5.1 Absolute Maximum Ratings

over operating free-air temperature range (unless otherwise noted)<sup>(1)</sup>

			MIN	MAX	UNIT
V <sub>CC</sub>	Supply voltage range		-0.5	7	V
V <sub>I</sub>	Input voltage range <sup>(2)</sup>		-0.5	V <sub>CC</sub> + 0.5V	V
V <sub>O</sub>	Output voltage range <sup>(2)</sup>		-0.5	V <sub>CC</sub> + 0.5V	V
I <sub>IK</sub>	Input clamp current	V <sub>I</sub> < -0.5V or V <sub>I</sub> > V <sub>CC</sub> + 0.5V		±20	mA
I <sub>OK</sub>	Output clamp current	V <sub>O</sub> < -0.5V or V <sub>O</sub> > V <sub>CC</sub> + 0.5V		±50	mA
I <sub>O</sub>	Continuous output current	V <sub>O</sub> = 0 to V <sub>CC</sub>		50	mA
	Continuous output current through V <sub>CC</sub> or GND			±200	mA
T <sub>J</sub>	Junction temperature			150	°C
T <sub>stg</sub>	Storage temperature		-65	150	°C

- (1) Operation outside the *Absolute Maximum Ratings* may cause permanent device damage. Absolute maximum ratings do not imply functional operation of the device at these or any other conditions beyond those listed under *Recommended Operating Conditions*. If briefly operating outside the *Recommended Operating Conditions* but within the *Absolute Maximum Ratings*, the device may not sustain damage, but it may not be fully functional. Operating the device in this manner may affect device reliability, functionality, performance, and shorten the device lifetime.
- (2) The input and output voltage ratings may be exceeded if the input and output current ratings are observed.

### 5.2 ESD Ratings

			VALUE	UNIT
V <sub>(ESD)</sub>	Electrostatic discharge	Human body model (HBM), per AEC Q100-002 HBM ESD Classification Level 2 <sup>(1)</sup>	±2000	V
		Charged device model (CDM), per AEC Q100-011 CDM ESD Classification Level C4B	±1000	

- (1) AEC Q100-002 indicate that HBM stressing shall be in accordance with the ANSI/ESDA/JEDEC JS-001 specification.

### 5.3 Recommended Operating Conditions

over operating free-air temperature range (unless otherwise noted)

Specification	Description	Condition	MIN	MAX	UNIT
V <sub>CC</sub>	Supply voltage	Supply voltage	1.5	6	V
V <sub>I</sub>	Input Voltage	Input Voltage	0	V <sub>CC</sub>	V
V <sub>O</sub>	Output Voltage	Output Voltage	0	V <sub>CC</sub>	V
I <sub>OL</sub>	Low-level output current	V <sub>CC</sub> = 1.8V		1	mA
		V <sub>CC</sub> = 2.5V		2	mA
		V <sub>CC</sub> = 3V		12	mA
		V <sub>CC</sub> = 4.5V to 5.5V		24	mA
T <sub>A</sub>	Operating free-air temperature	Operating free-air temperature	-40	125	°C

### 5.4 Thermal Information

THERMAL METRIC <sup>(1)</sup>		PW (TSSOP)	UNIT
		14 PINS	
R <sub>θJA</sub>	Junction-to-ambient thermal resistance	148.0	°C/W
R <sub>θJC(top)</sub>	Junction-to-case (top) thermal resistance	81.1	°C/W
R <sub>θJB</sub>	Junction-to-board thermal resistance	104.5	°C/W
Ψ <sub>JT</sub>	Junction-to-top characterization parameter	22.2	°C/W

## 5.4 Thermal Information (continued)

THERMAL METRIC <sup>(1)</sup>		PW (TSSOP)	UNIT
		14 PINS	
$\Psi_{JB}$	Junction-to-board characterization parameter	103.0	°C/W
$R_{\theta JC(bot)}$	Junction-to-case (bottom) thermal resistance	N/A	°C/W

(1) For more information about traditional and new thermal metrics, see the [Semiconductor and IC Package Thermal Metrics](#) application report.

## 5.5 Electrical Characteristics

over operating free-air temperature range (unless otherwise noted)

PARAMETER	TEST CONDITIONS	$V_{CC}$	-40°C to 125°C			UNIT
			MIN	TYP	MAX	
$V_{T+}$	Positive-going input threshold voltage	1.5V	0.61	0.89	1.17	V
		1.8V	0.72	1.03	1.33	
		2.5V	0.8	1.29	1.61	
		3V	0.8	1.8	2.2	
		4.5V	1.5	2.6	3.2	
		5V	1.5		3.55	
		5.5V	1.6	3.2	3.9	
$V_{T-}$	Negative-going input threshold voltage	1.5V	0.26	0.48	0.7	V
		1.8V	0.37	0.54	0.70	
		2.5V	0.5	0.7	0.84	
		3V	0.5	0.8	1.2	
		4.5V	0.9	1.4	1.8	
		5V	1.0		2.05	
		5.5V	1.1	1.8	2.3	
$\Delta V_T$	Hysteresis ( $V_{T+} - V_{T-}$ )	1.5V	0.11	0.41	0.83	V
		1.8V	0.28	0.49	0.83	
		2.5V	0.3	0.60	0.83	
		3V	0.3	1	1.2	
		4.5V	0.4	1.2	1.4	
		5V	0.5			
		5.5V	0.5	1.4	1.6	
$V_{OL}$	$I_{OL} = 50\mu A$	1.5V			0.1	V
		1.8V			0.1	
		2.5V			0.1	
		3V		0.002	0.1	
		4.5V		0.001	0.1	
		5.5V		0.001	0.1	
		$I_{OL} = 1mA$	1.8V			
	$I_{OL} = 2mA$	2.5V			0.5	
	$I_{OL} = 4mA$	3V			0.5	
	$I_{OL} = 12mA$	3V			0.5	
	$I_{OL} = 24mA$	4.5V			0.5	
	$I_{OL} = 24mA$	5.5V			0.5	
	$I_{OL} = 75mA$	5.5V			1.65	
$I_{OL} = 50mA$	5.5V			1.65		

## 5.5 Electrical Characteristics (continued)

over operating free-air temperature range (unless otherwise noted)

PARAMETER	TEST CONDITIONS	V <sub>CC</sub>	-40°C to 125°C			UNIT
			MIN	TYP	MAX	
I <sub>I</sub>	V <sub>I</sub> = 5.5V or GND	0V to 5.5V			±1	μA
I <sub>OZ</sub>	V <sub>O</sub> = 5.5V or GND	0V to 5.5V			±5	μA
I <sub>CC</sub>	V <sub>I</sub> = V <sub>CC</sub> or GND, I <sub>O</sub> = 0	5.5V			20	μA
C <sub>I</sub>	V <sub>I</sub> = V <sub>CC</sub> or GND	5V		9		pF
C <sub>O</sub>	V <sub>O</sub> = V <sub>CC</sub> or GND	5V		15		pF
C <sub>PD</sub>	C <sub>L</sub> = 50pF, F = 1MHz	5V		60		pF

## 5.6 Switching Characteristics

C<sub>L</sub> = 50pF; over operating free-air temperature range; typical values measured at T<sub>A</sub> = 25°C (unless otherwise noted). See *Parameter Measurement Information*

PARAMETER	FROM (INPUT)	TO (OUTPUT)	V <sub>CC</sub>	-40°C to 125°C			UNIT
				MIN	TYP	MAX	
t <sub>PLZ</sub>	A	Y	1.5V			27.2	ns
			1.8V			17.7	ns
			2.5V			8.2	ns
			3.3V			6.3	ns
			5V			4.5	ns
t <sub>PZL</sub>	A	Y	1.5V			30.9	ns
			1.8V			20.2	ns
			2.5V			13.4	ns
			3.3V			11	ns
			5V			7.7	ns

### 5.7 Typical Characteristics

T<sub>A</sub> = 25°C (unless otherwise noted)

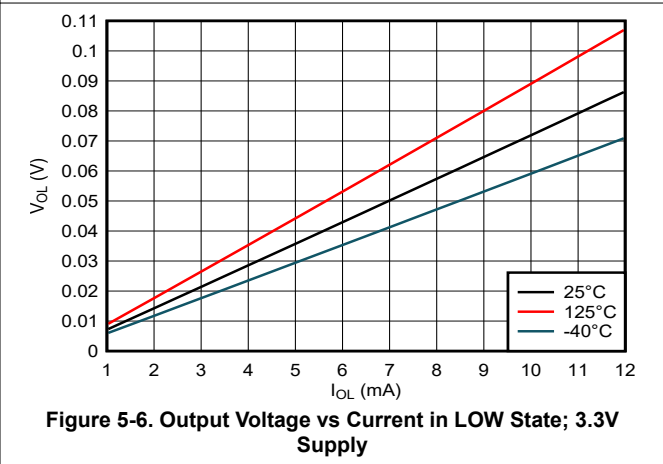
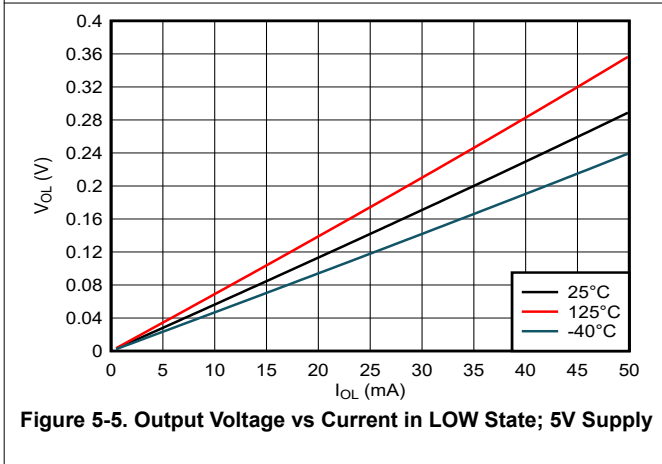
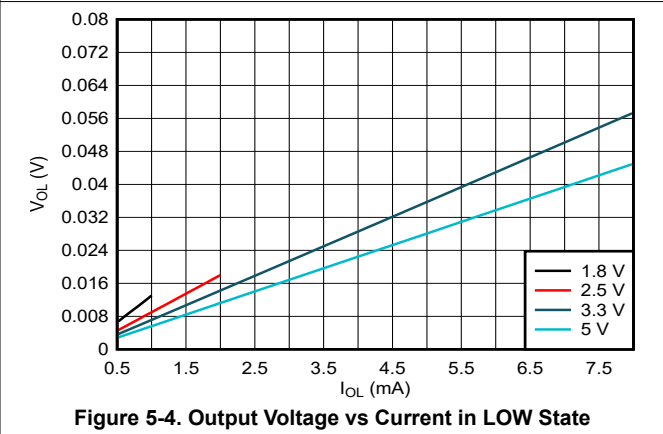
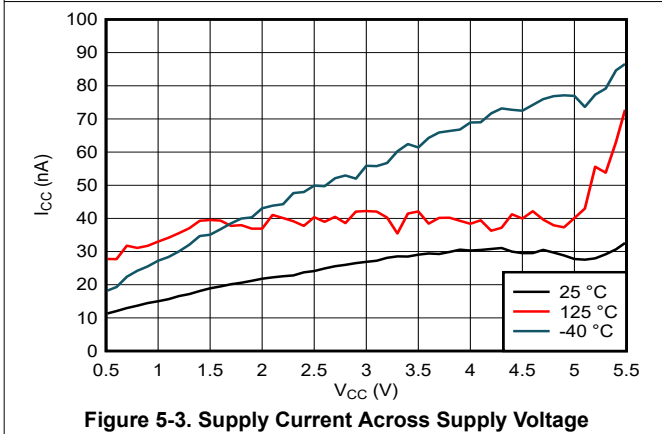
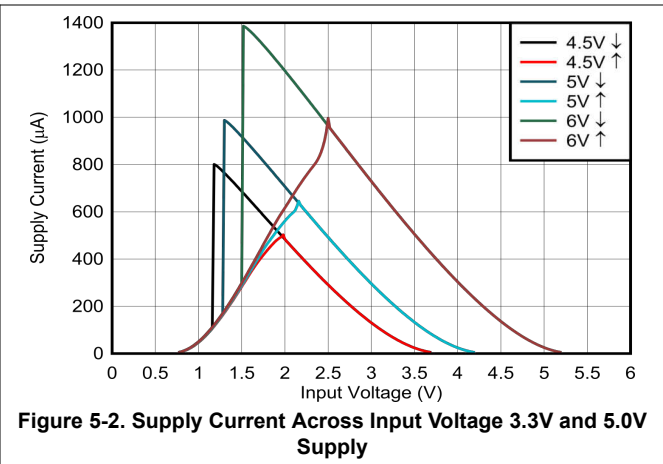
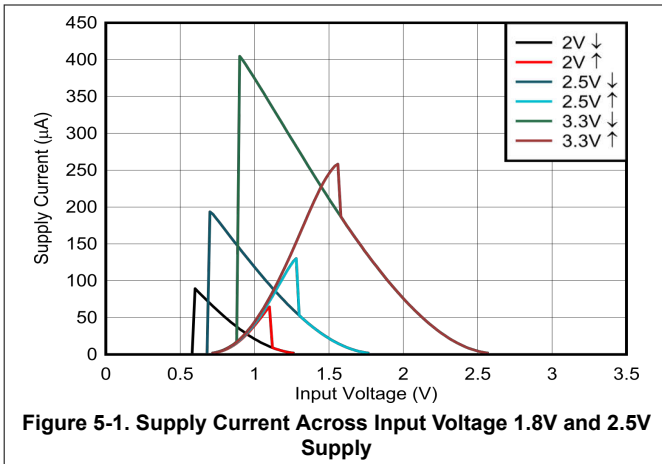

### 5.7 Typical Characteristics (continued)

T<sub>A</sub> = 25°C (unless otherwise noted)

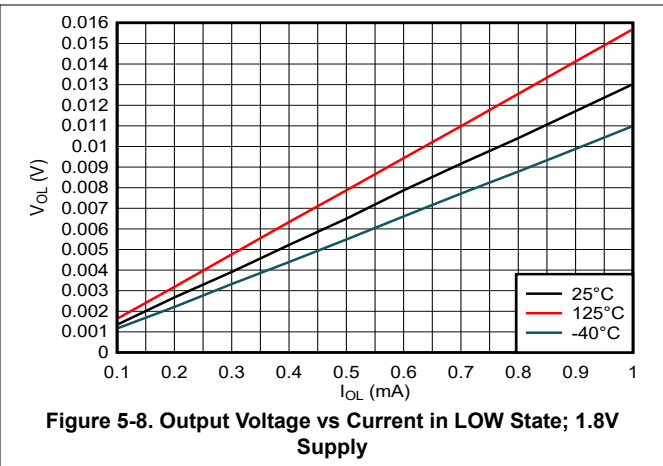
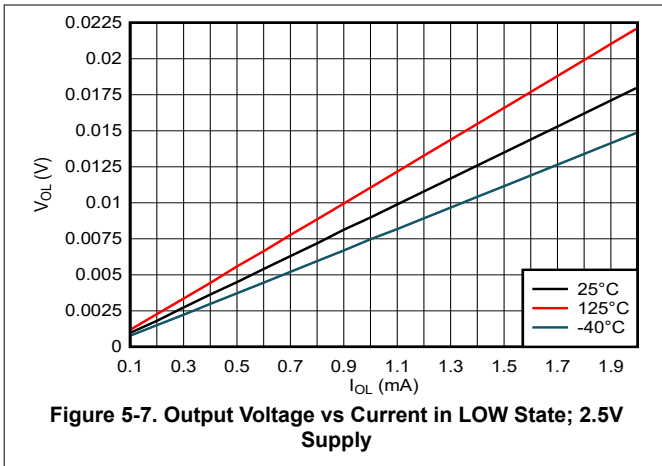

### 6 Parameter Measurement Information

Phase relationships between waveforms were chosen arbitrarily for the examples listed in the following table. All input pulses are supplied by generators having the following characteristics: PRR ≤ 1MHz, Z<sub>O</sub> = 50Ω, t<sub>t</sub> < 2.5.

The outputs are measured individually with one input transition per measurement.

TEST	S1	R <sub>L</sub>	C <sub>L</sub>	ΔV	V <sub>CC</sub>
t <sub>PLZ</sub> , t <sub>PZL</sub>	CLOSED	1kΩ	50 pF	0.15V	≤ 2.5V
t <sub>PLZ</sub> , t <sub>PZL</sub>	CLOSED	1kΩ	50 pF	0.3V	> 2.5V

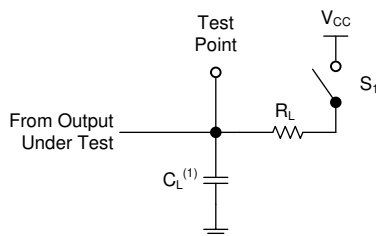

(1) C<sub>L</sub> includes probe and test-fixture capacitance.

**Figure 6-1. Load Circuit for Open-Drain Outputs**

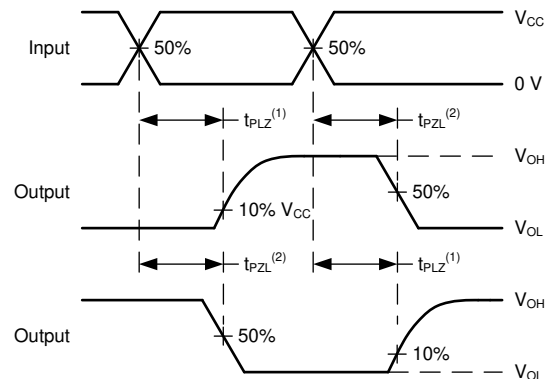

(1) t<sub>PLZ</sub> is the same as t<sub>dis</sub>.

(2) t<sub>PZL</sub> is the same as t<sub>en</sub>.

**Figure 6-2. Voltage Waveforms Propagation Delays**

## 7 Detailed Description

### 7.1 Overview

The SN74AC16-Q1 hex inverters provide the logic function  $Y = \bar{A}$ .

### 7.2 Functional Block Diagram

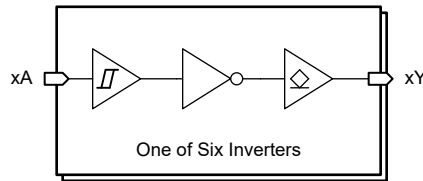

Logic Diagram (Positive Logic)

### 7.3 Feature Description

#### 7.3.1 Open-Drain CMOS Outputs

This device includes open-drain CMOS outputs. Open-drain outputs can only drive the output low. When in the high logical state, open-drain outputs will be in a high-impedance state. The drive capability of this device may create fast edges into light loads, so routing and load conditions should be considered to prevent ringing. Additionally, the outputs of this device are capable of driving larger currents than the device can sustain without being damaged. It is important for the output power of the device to be limited to avoid damage due to overcurrent. The electrical and thermal limits defined in the *Absolute Maximum Ratings* must be followed at all times.

When placed into the high-impedance state, the output will neither source nor sink current, with the exception of minor leakage current as defined in the *Electrical Characteristics* table. In the high-impedance state, the output voltage is not controlled by the device and is dependent on external factors. If no other drivers are connected to the node, then this is known as a floating node and the voltage is unknown. A pull-up resistor can be connected to the output to provide a known voltage at the output while it is in the high-impedance state. The value of the resistor will depend on multiple factors, including parasitic capacitance and power consumption limitations. Typically, a 10kΩ resistor can be used to meet these requirements.

Unused open-drain CMOS outputs should be left disconnected.

#### 7.3.2 CMOS Schmitt-Trigger Inputs

This device includes inputs with the Schmitt-trigger architecture. These inputs are high impedance and are typically modeled as a resistor in parallel with the input capacitance given in the *Electrical Characteristics* table from the input to ground. The worst case resistance is calculated with the maximum input voltage, given in the *Absolute Maximum Ratings* table, and the maximum input leakage current, given in the *Electrical Characteristics* table, using Ohm's law ( $R = V \div I$ ).

The Schmitt-trigger input architecture provides hysteresis as defined by  $\Delta V_T$  in the *Electrical Characteristics* table, which makes this device extremely tolerant to slow or noisy inputs. While the inputs can be driven much slower than standard CMOS inputs, it is still recommended to properly terminate unused inputs. Driving the inputs with slow transitioning signals will increase dynamic current consumption of the device. For additional information regarding Schmitt-trigger inputs, please see [Understanding Schmitt Triggers](#).

## 7.4 Device Functional Modes

Table 7-1 lists the function modes of the SN74AC16-Q1.

**Table 7-1. Function Table**

INPUTS <sup>(1)</sup>	OUTPUTS
A	Y
L	Z
H	L

(1) H = High Voltage Level, L = Low Voltage Level

## 8 Application and Implementation

### Note

Information in the following applications sections is not part of the TI component specification, and TI does not warrant its accuracy or completeness. TI's customers are responsible for determining suitability of components for their purposes, as well as validating and testing their design implementation to confirm system functionality.

### 8.1 Application Information

In this application, an open-drain inverter is used to drive a low voltage relay coil as shown in [Figure 8-1](#). The high drive strength of the SN74AC16-Q1 allows direct driving of the relay coil. When the open-drain output of the device is set to the high-impedance mode, the current from the coil cannot change to zero as fast as the output can, so the output positive clamp diode provides a safe path for that current until it dissipates. A typical coil current and diode current are plotted in [Figure 8-2](#), showing the normal diode current behavior while driving an inductive load.

### 8.2 Typical Application

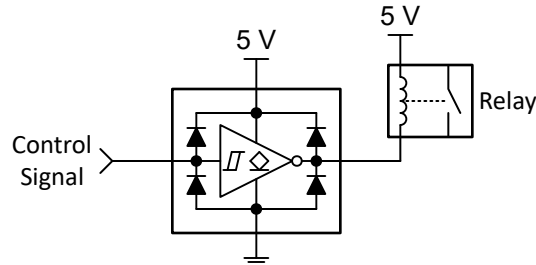

**Figure 8-1. Typical Application Block Diagram**

#### 8.2.1 Design Requirements

##### 8.2.1.1 Power Considerations

Ensure the desired supply voltage is within the range specified in the *Recommended Operating Conditions*. The supply voltage sets the device's electrical characteristics of the device as described in the *Electrical Characteristics* section.

The positive voltage supply must be capable of sourcing current equal to the maximum static supply current,  $I_{CC}$ , listed in the *Electrical Characteristics*, and any transient current required for switching.

The ground must be capable of sinking current equal to the total current to be sunk by all outputs of the SN74AC16-Q1 plus the maximum supply current,  $I_{CC}$ , listed in the *Electrical Characteristics*, and any transient current required for switching. The logic device can only sink as much current that can be sunk into its ground connection. Ensure the maximum total current through GND listed in the *Absolute Maximum Ratings* is not exceeded.

The SN74AC16-Q1 can drive a load with a total capacitance less than or equal to 50pF while still meeting all of the data sheet specifications. Larger capacitive loads can be applied; however, it is not recommended to exceed 50pF.

The SN74AC16-Q1 can drive a load with total resistance described by  $R_L \geq V_O / I_O$ , with the output voltage and current defined in the *Electrical Characteristics* table with  $V_{OL}$ . When outputting in the HIGH state, the output voltage in the equation is defined as the difference between the measured output voltage and the supply voltage at the  $V_{CC}$  pin.

Total power consumption can be calculated using the information provided in [CMOS Power Consumption and Cpd Calculation](#).

Thermal increase can be calculated using the information provided in [Thermal Characteristics of Standard Linear and Logic \(SLL\) Packages and Devices](#).

#### CAUTION

The maximum junction temperature,  $T_{J(max)}$  listed in the *Absolute Maximum Ratings*, is an additional limitation to prevent damage to the device. Do not violate any values listed in the *Absolute Maximum Ratings*. These limits are provided to prevent damage to the device.

#### 8.2.1.2 Input Considerations

Input signals must cross  $V_{t-(min)}$  to be considered a logic LOW, and  $V_{t+(max)}$  to be considered a logic HIGH. Do not exceed the maximum input voltage range found in the *Absolute Maximum Ratings*.

Unused inputs must be terminated to either  $V_{CC}$  or ground. The unused inputs can be directly terminated if the input is completely unused, or they can be connected with a pull-up or pull-down resistor if the input will be used sometimes, but not always. A pull-up resistor is used for a default state of HIGH, and a pull-down resistor is used for a default state of LOW. The drive current of the controller, leakage current into the SN74AC16-Q1 (as specified in the *Electrical Characteristics*), and the desired input transition rate limits the resistor size. A 10k $\Omega$  resistor value is often used due to these factors.

The SN74AC16-Q1 has no input signal transition rate requirements because it has Schmitt-Trigger inputs.

Another benefit to having Schmitt-Trigger inputs is the ability to reject noise. Noise with a large enough amplitude can still cause issues. To know how much noise is too much, please refer to the  $\Delta V_{T(min)}$  in the *Electrical Characteristics*. This hysteresis value will provide the peak-to-peak limit.

Unlike what happens with standard CMOS inputs, Schmitt-Trigger inputs can be held at any valid value without causing huge increases in power consumption. The typical additional current caused by holding an input at a value other than  $V_{CC}$  or ground is plotted in the *Typical Characteristics*.

Refer to the *Feature Description* section for additional information regarding the inputs for this device.

#### 8.2.1.3 Output Considerations

The ground voltage is used to produce the output LOW voltage. Sinking current into the output will increase the output voltage as specified by the  $V_{OL}$  specification in the *Electrical Characteristics*.

Open-drain outputs can be connected together directly to produce a wired-AND configuration or for additional output drive strength.

Unused outputs can be left floating. Do not connect outputs directly to  $V_{CC}$  or ground.

Refer to the *Feature Description* section for additional information regarding the outputs for this device.

### 8.2.2 Detailed Design Procedure

1. Add a decoupling capacitor from  $V_{CC}$  to GND. The capacitor needs to be placed physically close to the device and electrically close to both the  $V_{CC}$  and GND pins. An example layout is shown in the *Layout* section.
2. Ensure the capacitive load at the output is  $\leq 50$ pF. This is not a hard limit; by design, however, it will optimize performance. This can be accomplished by providing short, appropriately sized traces from the SN74AC16-Q1 to one or more of the receiving devices.
3. Ensure the resistive load at the output is larger than  $(V_{CC} / I_{O(max)})\Omega$ . Doing this will prevent the maximum output current from the *Absolute Maximum Ratings* from being violated. Most CMOS inputs have a resistive load measured in M $\Omega$ ; much larger than the minimum calculated previously.
4. Thermal issues are rarely a concern for logic gates; the power consumption and thermal increase, however, can be calculated using the steps provided in the application report, [CMOS Power Consumption and Cpd Calculation](#).

### 8.2.3 Application Curves

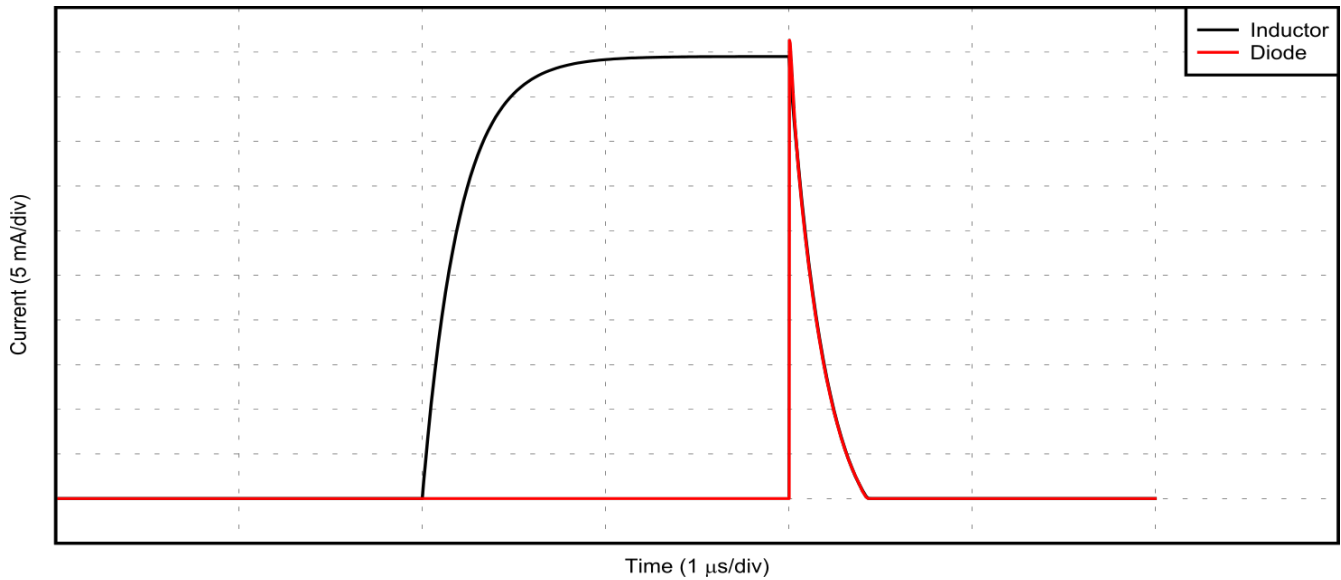

**Figure 8-2. Application Curve**

### 8.3 Power Supply Recommendations

The power supply can be any voltage between the MIN and MAX supply voltage rating located in the [Section 5.3](#).

Each  $V_{CC}$  pin should have a good bypass capacitor to prevent power disturbance. For devices with a single supply, 0.1  $\mu\text{F}$  is recommended; if there are multiple  $V_{CC}$  pins, then 0.01  $\mu\text{F}$  or 0.022  $\mu\text{F}$  is recommended for each power pin. It is acceptable to parallel multiple bypass caps to reject different frequencies of noise. A 0.1  $\mu\text{F}$  and a 1  $\mu\text{F}$  are commonly used in parallel. The bypass capacitor should be installed as close to the power pin as possible for best results.

### 8.4 Layout

#### 8.4.1 Layout Guidelines

When using multiple-bit logic devices, inputs should never float.

In many cases, functions or parts of functions of digital logic devices are unused, for example, when only two inputs of a triple-input AND gate are used or only 3 of the 4 buffer gates are used. Such input pins should not be left unconnected because the undefined voltages at the outside connections result in undefined operational states. [Figure 8-3](#) specifies the rules that must be observed under all circumstances. All unused inputs of digital logic devices must be connected to a high or low bias to prevent them from floating. The logic level that should be applied to any particular unused input depends on the function of the device. Generally they will be tied to GND or  $V_{CC}$ , whichever makes more sense or is more convenient. It is generally acceptable to float outputs, unless the part is a transceiver. If the transceiver has an output enable pin, it will disable the output section of the part when asserted. This will not disable the input section of the IOs, so they cannot float when disabled.

### 8.4.2 Layout Example

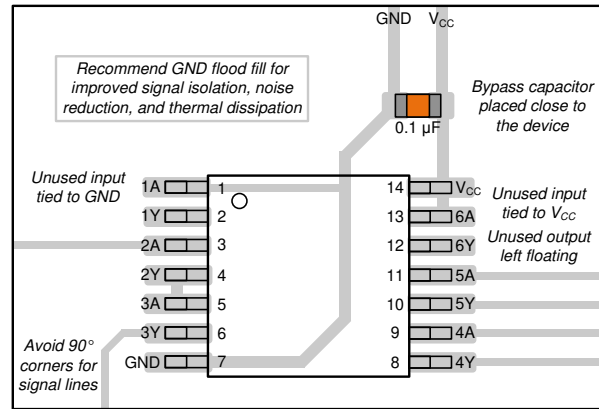

Figure 8-3. Example Layout for the SN74AC16-Q1

## 9 Device and Documentation Support

### 9.1 Receiving Notification of Documentation Updates

To receive notification of documentation updates, navigate to the device product folder on [ti.com](http://ti.com). Click on *Notifications* to register and receive a weekly digest of any product information that has changed. For change details, review the revision history included in any revised document.

### 9.2 Support Resources

[TI E2E™ support forums](#) are an engineer's go-to source for fast, verified answers and design help — straight from the experts. Search existing answers or ask your own question to get the quick design help you need.

Linked content is provided "AS IS" by the respective contributors. They do not constitute TI specifications and do not necessarily reflect TI's views; see TI's [Terms of Use](#).

### 9.3 Trademarks

TI E2E™ is a trademark of Texas Instruments.  
All trademarks are the property of their respective owners.

### 9.4 Electrostatic Discharge Caution



This integrated circuit can be damaged by ESD. Texas Instruments recommends that all integrated circuits be handled with appropriate precautions. Failure to observe proper handling and installation procedures can cause damage.

ESD damage can range from subtle performance degradation to complete device failure. Precision integrated circuits may be more susceptible to damage because very small parametric changes could cause the device not to meet its published specifications.

### 9.5 Glossary

[TI Glossary](#) This glossary lists and explains terms, acronyms, and definitions.

## 10 Revision History

Changes from Revision * (February 2024) to Revision A (July 2024)	Page
• Changed from Advance Information to Production Data.....	1

## 11 Mechanical, Packaging, and Orderable Information

The following pages include mechanical, packaging, and orderable information. This information is the most current data available for the designated devices. This data is subject to change without notice and revision of this document. For browser-based versions of this data sheet, refer to the left-hand navigation.

**SN74AC16-Q1**

SCAS966A – FEBRUARY 2024 – REVISED JULY 2024

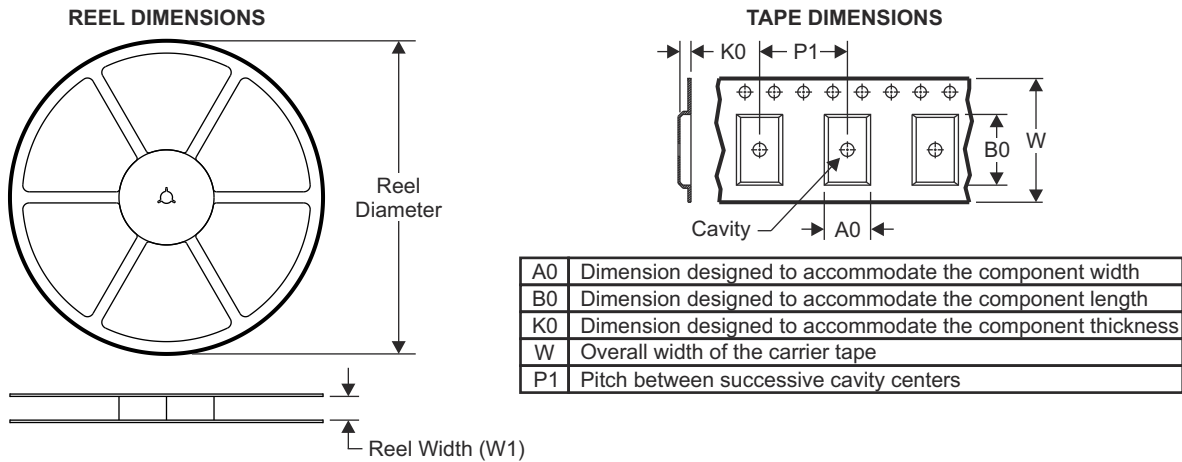
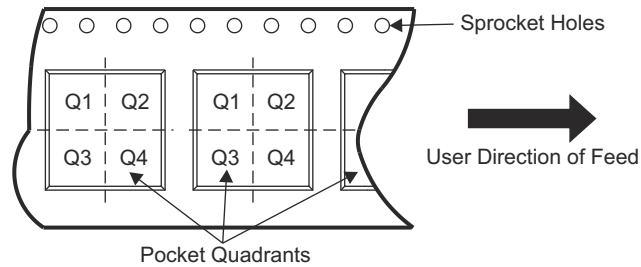
**11.1 Tape and Reel Information**

**QUADRANT ASSIGNMENTS FOR PIN 1 ORIENTATION IN TAPE**

Device	Package Type	Package Drawing	Pins	SPQ	Reel Diameter (mm)	Reel Width W1 (mm)	A0 (mm)	B0 (mm)	K0 (mm)	P1 (mm)	W (mm)	Pin1 Quadrant
PSN74AC16PWRQ1	TSSOP	PW	14	3000	330	12	6.90	5.60	1.60	8	12	Q1

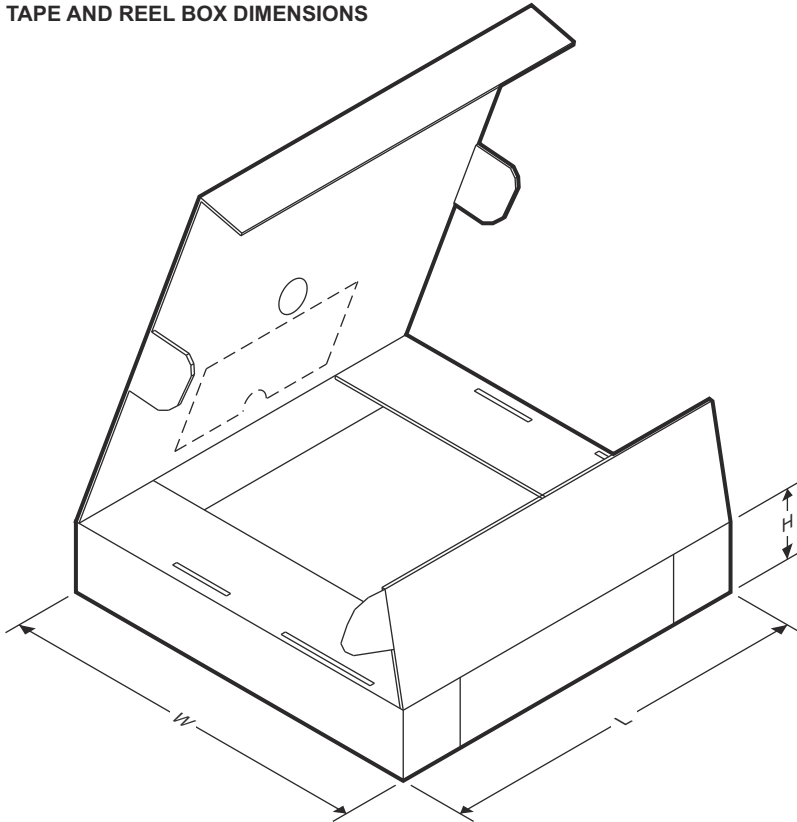
**TAPE AND REEL BOX DIMENSIONS**



Device	Package Type	Package Drawing	Pins	SPQ	Length (mm)	Width (mm)	Height (mm)
PSN74AC16PWRQ1	TSSOP	PW	14	3000	356	356	35



**THERMAL PAD MECHANICAL DATA**

PWP (R-PDSO-G14) PowerPAD™ SMALL PLASTIC OUTLINE

**THERMAL INFORMATION**

This PowerPAD™ package incorporates an exposed thermal pad that is designed to be attached to a printed circuit board (PCB). The thermal pad must be soldered directly to the PCB. After soldering, the PCB can be used as a heatsink. In addition, through the use of thermal vias, the thermal pad can be attached directly to the appropriate copper plane shown in the electrical schematic for the device, or alternatively, can be attached to a special heatsink structure designed into the PCB. This design optimizes the heat transfer from the integrated circuit (IC).

For additional information on the PowerPAD package and how to take advantage of its heat dissipating abilities, refer to Technical Brief, PowerPAD Thermally Enhanced Package, Texas Instruments Literature No. SLMA002 and Application Brief, PowerPAD Made Easy, Texas Instruments Literature No. SLMA004. Both documents are available at www.ti.com.

The exposed thermal pad dimensions for this package are shown in the following illustration.

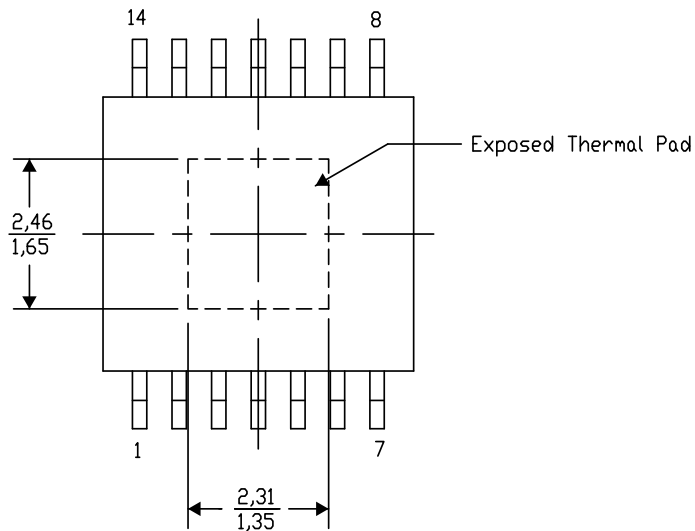

Top View

Exposed Thermal Pad Dimensions

4206332-2/A0 01/16

NOTE: A. All linear dimensions are in millimeters

PowerPAD is a trademark of Texas Instruments

LAND PATTERN DATA

PWP (R-PDSO-G14)

PowerPAD™ PLASTIC SMALL OUTLINE

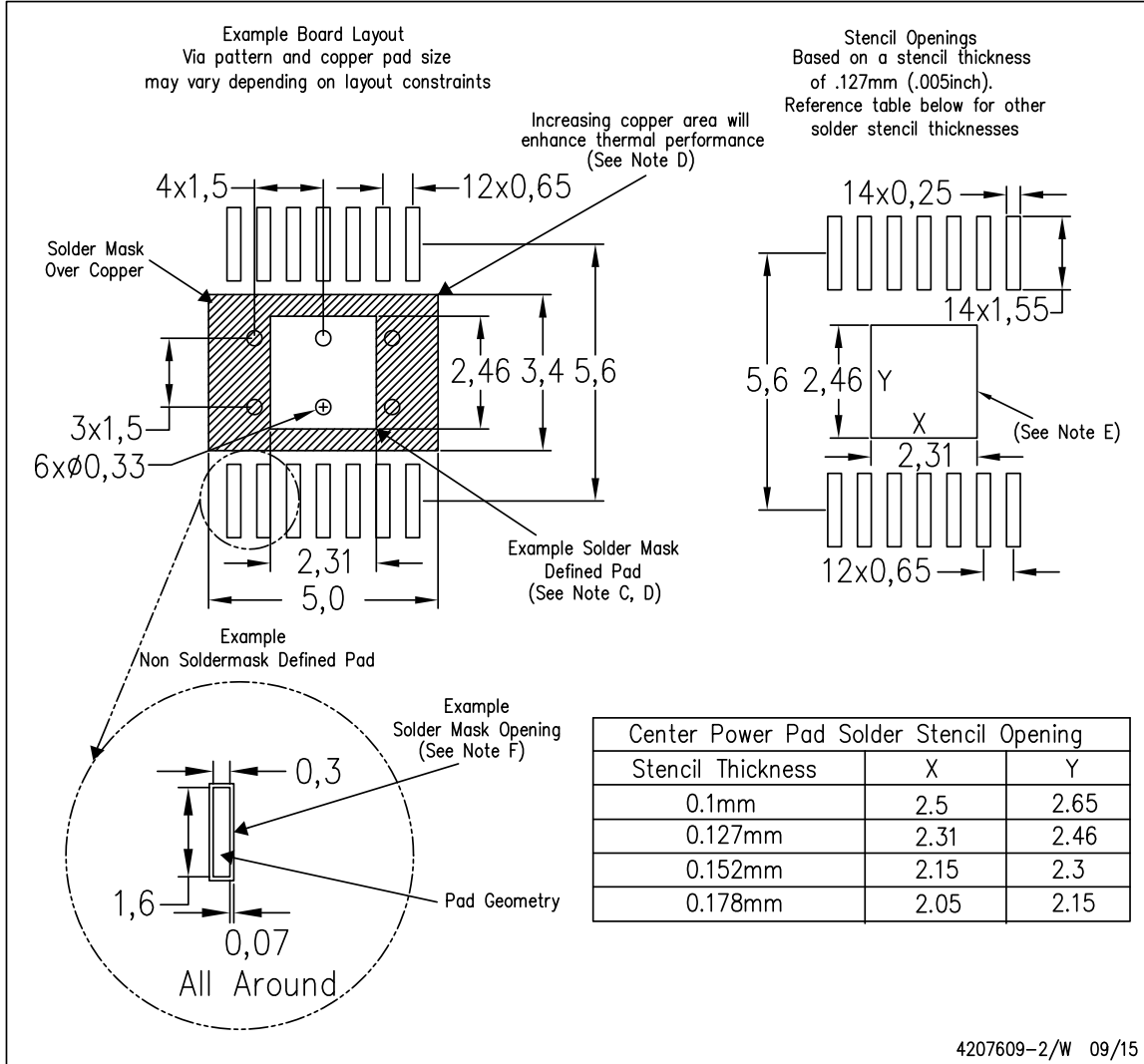

- NOTES:
- A. All linear dimensions are in millimeters.
  - B. This drawing is subject to change without notice.
  - C. Customers should place a note on the circuit board fabrication drawing not to alter the center solder mask defined pad.
  - D. This package is designed to be soldered to a thermal pad on the board. Refer to Technical Brief, PowerPad Thermally Enhanced Package, Texas Instruments Literature No. SLMA002, SLMA004, and also the Product Data Sheets for specific thermal information, via requirements, and recommended board layout. These documents are available at [www.ti.com](http://www.ti.com) <<http://www.ti.com>>. Publication IPC-7351 is recommended for alternate designs.
  - E. Laser cutting apertures with trapezoidal walls and also rounding corners will offer better paste release. Customers should contact their board assembly site for stencil design recommendations. Example stencil design based on a 50% volumetric metal load solder paste. Refer to IPC-7525 for other stencil recommendations.
  - F. Customers should contact their board fabrication site for solder mask tolerances between and around signal pads.

**PACKAGING INFORMATION**

Orderable Device	Status (1)	Package Type	Package Drawing	Pins	Package Qty	Eco Plan (2)	Lead finish/ Ball material (6)	MSL Peak Temp (3)	Op Temp (°C)	Device Marking (4/5)	Samples
PSN74AC16PWRQ1	ACTIVE	TSSOP	PW	14	3000	TBD	Call TI	Call TI	-40 to 125		Samples

(1) The marketing status values are defined as follows:

**ACTIVE:** Product device recommended for new designs.

**LIFEBUY:** TI has announced that the device will be discontinued, and a lifetime-buy period is in effect.

**NRND:** Not recommended for new designs. Device is in production to support existing customers, but TI does not recommend using this part in a new design.

**PREVIEW:** Device has been announced but is not in production. Samples may or may not be available.

**OBSELETE:** TI has discontinued the production of the device.

(2) **RoHS:** TI defines "RoHS" to mean semiconductor products that are compliant with the current EU RoHS requirements for all 10 RoHS substances, including the requirement that RoHS substance do not exceed 0.1% by weight in homogeneous materials. Where designed to be soldered at high temperatures, "RoHS" products are suitable for use in specified lead-free processes. TI may reference these types of products as "Pb-Free".

**RoHS Exempt:** TI defines "RoHS Exempt" to mean products that contain lead but are compliant with EU RoHS pursuant to a specific EU RoHS exemption.

**Green:** TI defines "Green" to mean the content of Chlorine (Cl) and Bromine (Br) based flame retardants meet JS709B low halogen requirements of <=1000ppm threshold. Antimony trioxide based flame retardants must also meet the <=1000ppm threshold requirement.

(3) MSL, Peak Temp. - The Moisture Sensitivity Level rating according to the JEDEC industry standard classifications, and peak solder temperature.

(4) There may be additional marking, which relates to the logo, the lot trace code information, or the environmental category on the device.

(5) Multiple Device Markings will be inside parentheses. Only one Device Marking contained in parentheses and separated by a "-" will appear on a device. If a line is indented then it is a continuation of the previous line and the two combined represent the entire Device Marking for that device.

(6) Lead finish/Ball material - Orderable Devices may have multiple material finish options. Finish options are separated by a vertical ruled line. Lead finish/Ball material values may wrap to two lines if the finish value exceeds the maximum column width.

**Important Information and Disclaimer:**The information provided on this page represents TI's knowledge and belief as of the date that it is provided. TI bases its knowledge and belief on information provided by third parties, and makes no representation or warranty as to the accuracy of such information. Efforts are underway to better integrate information from third parties. TI has taken and continues to take reasonable steps to provide representative and accurate information but may not have conducted destructive testing or chemical analysis on incoming materials and chemicals. TI and TI suppliers consider certain information to be proprietary, and thus CAS numbers and other limited information may not be available for release.

In no event shall TI's liability arising out of such information exceed the total purchase price of the TI part(s) at issue in this document sold by TI to Customer on an annual basis.

## IMPORTANT NOTICE AND DISCLAIMER

TI PROVIDES TECHNICAL AND RELIABILITY DATA (INCLUDING DATA SHEETS), DESIGN RESOURCES (INCLUDING REFERENCE DESIGNS), APPLICATION OR OTHER DESIGN ADVICE, WEB TOOLS, SAFETY INFORMATION, AND OTHER RESOURCES "AS IS" AND WITH ALL FAULTS, AND DISCLAIMS ALL WARRANTIES, EXPRESS AND IMPLIED, INCLUDING WITHOUT LIMITATION ANY IMPLIED WARRANTIES OF MERCHANTABILITY, FITNESS FOR A PARTICULAR PURPOSE OR NON-INFRINGEMENT OF THIRD PARTY INTELLECTUAL PROPERTY RIGHTS.

These resources are intended for skilled developers designing with TI products. You are solely responsible for (1) selecting the appropriate TI products for your application, (2) designing, validating and testing your application, and (3) ensuring your application meets applicable standards, and any other safety, security, regulatory or other requirements.

These resources are subject to change without notice. TI grants you permission to use these resources only for development of an application that uses the TI products described in the resource. Other reproduction and display of these resources is prohibited. No license is granted to any other TI intellectual property right or to any third party intellectual property right. TI disclaims responsibility for, and you will fully indemnify TI and its representatives against, any claims, damages, costs, losses, and liabilities arising out of your use of these resources.

TI's products are provided subject to [TI's Terms of Sale](#) or other applicable terms available either on [ti.com](https://www.ti.com) or provided in conjunction with such TI products. TI's provision of these resources does not expand or otherwise alter TI's applicable warranties or warranty disclaimers for TI products.

TI objects to and rejects any additional or different terms you may have proposed.

Mailing Address: Texas Instruments, Post Office Box 655303, Dallas, Texas 75265  
Copyright © 2024, Texas Instruments Incorporated