

# TPS7H1111-SP and TPS7H1111-SEP 1.5-A, Ultra-Low Noise, High PSRR Radiation Hardened Low Dropout (LDO) Linear Regulator

## 1 Features

- **Total ionizing dose (TID) characterized**
  - Radiation hardness assurance (RHA) availability of 100 krad(Si) or 50 krad(Si)
- **Single-Event Effects (SEE) characterized**
  - Single-event latchup (SEL), single-event burnout (SEB), and single-event gate rupture (SEGR) immune up to linear energy transfer (LET) = 75 MeV-cm<sup>2</sup>/mg
  - Single-event functional interrupt (SEFI) and single-event transient (SET) characterized up to LET = 75 MeV-cm<sup>2</sup>/mg
- Ultra-low noise (10 Hz to 100 kHz):
  - 1.71 μV<sub>RMS</sub> (typ)
- High power-supply rejection ratio, PSRR (typ):
  - 109 dB at 1 kHz
  - 71 dB at 100 kHz
  - 66 dB at 1 MHz
- Input voltage range from 0.85 V to 7 V
- Bias supply of 2.2 V to 14 V to minimize power dissipation
- Output voltage as low as 0.4 V
- Up to 1.5-A output current
- Excellent output accuracy over line and load:
  - -1.3% to +1.2% across temperature
  - -0.7% to +0.9% at 25°C
- Low-dropout: 215 mV (typ) at 1.5 A
- Programmable soft-start control (SS\_SET)
- Open-drain power good (PG) indicator
- Configurable power good threshold (FB\_PG)
- Exposed control loop with the external compensation STAB pin
- Internal current limit with configurable behavior
- Current sharing to allow operation of up to 2.9 A
- Military temperature range (-55°C to 125°C)

## 2 Applications

- **Satellite electrical power system (EPS)**
- Power for high-speed and high-accuracy circuits
  - Data converters: ADCs and DACs (analog-to-digital and digital-to-analog converters)
  - VCOs (voltage controlled oscillators)
  - PLLs (phase-locked loops)
  - SerDes (serializers and deserializers)
  - Imaging sensors
- Accurate supply for FPGAs (field programmable gate arrays) and DSPs (digital signal processors)
- Radiation-hardened ultra-clean analog supply for space constrained areas

## 3 Description

The TPS7H1111 is an ultra-low noise, high PSRR, low dropout linear regulator (LDO) optimized for powering radio-frequency (RF) devices in a space environment. It is capable of sourcing up to 1.5 A over a 0.85-V to 7-V input range with a 2.2-V to 14-V bias supply.

The high performance of the device limits power-supply generated phase noise and clock jitter, making this device ideal for powering high-performance ADCs, DACs, VCOs, PLLs, SerDes, and other RF components in satellites. For digital loads (such as FPGAs and DSPs) requiring low voltage operation, the exceptional accuracy and excellent transient performance ensure optimal system performance.

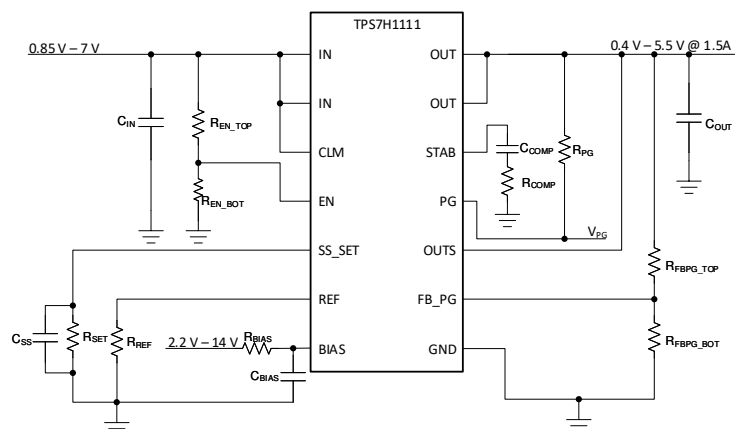
A standard microcircuit drawing (SMD) is available for the QML variants, [5962R21203](#). A vendor item drawing (VID) is available for the -SEP variant, [V62/23602](#).

### Device Information

PART NUMBER <sup>(1)</sup>	GRADE	PACKAGE <sup>(2)</sup>
5962R2120301VXC	QMLV-RHA	14-pin ceramic 8.03 mm × 9.12 mm Mass = 1.23 g
TPS7H1111HBL/EM	Engineering sample	
5962R2120302PYE	QMLP-RHA	28-pin plastic 4.40 mm × 9.70 mm Mass = 198 mg
TPS7H1111MPWPTSEP	SEP	

(1) For additional information view the [Device Options Table](#).

(2) Dimension and mass values are nominal.



Typical Application Circuit



## Table of Contents

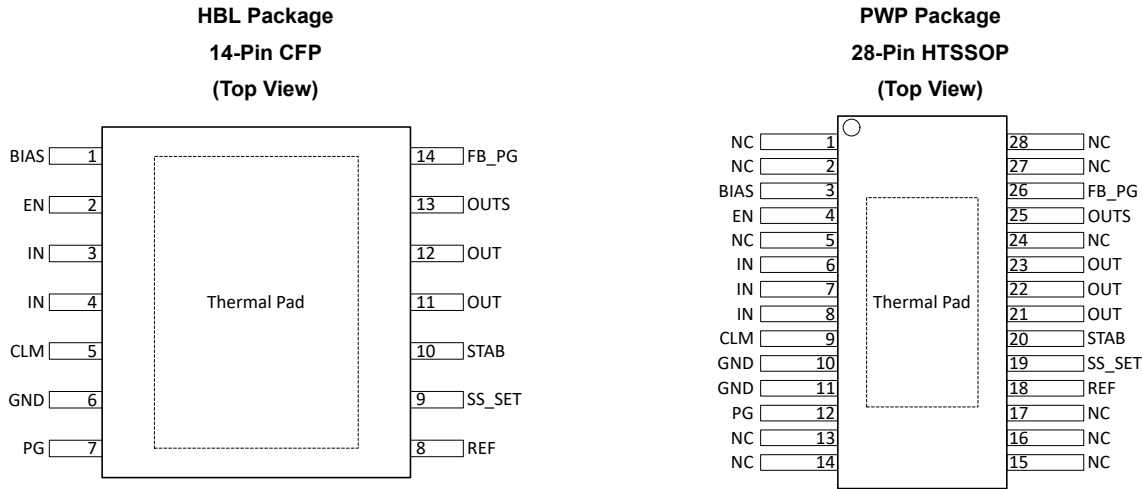
<b>1 Features</b> .....	1	8.4 Device Functional Modes.....	40
<b>2 Applications</b> .....	1	<b>9 Application and Implementation</b> .....	41
<b>3 Description</b> .....	1	9.1 Application Information.....	41
<b>4 Device Options Table</b> .....	3	9.2 Typical Applications.....	41
<b>5 Pin Configuration and Functions</b> .....	4	9.3 Capacitors Tested.....	48
<b>6 Specifications</b> .....	6	9.4 TID Effects.....	48
6.1 Absolute Maximum Ratings.....	6	9.5 Power Supply Recommendations.....	50
6.2 ESD Ratings.....	6	9.6 Layout.....	51
6.3 Recommended Operating Conditions.....	7	<b>10 Device and Documentation Support</b> .....	53
6.4 Thermal Information.....	7	10.1 Documentation Support.....	53
6.5 Electrical Characteristics.....	8	10.2 Receiving Notification of Documentation Updates..	53
6.6 Quality Conformance Inspection.....	11	10.3 Support Resources.....	53
6.7 Typical Characteristics.....	12	10.4 Trademarks.....	53
<b>7 Parameter Measurement Information</b> .....	25	10.5 Electrostatic Discharge Caution.....	53
<b>8 Detailed Description</b> .....	26	10.6 Glossary.....	53
8.1 Overview.....	26	<b>11 Revision History</b> .....	53
8.2 Functional Block Diagram.....	26	<b>12 Mechanical, Packaging, and Orderable Information</b> .....	55
8.3 Feature Description.....	27		

## 4 Device Options Table

GENERIC PART NUMBER	RADIATION RATING <sup>(1)</sup>	GRADE <sup>(2)</sup>	PACKAGE	ORDERABLE PART NUMBER
TPS7H1111-SP	TID of 100 krad(Si) RLAT, DSEE free to 75 MeV-cm <sup>2</sup> /mg	QMLV-RHA	14-pin CFP HBL	5962R2120301VXC
		QMLP-RHA	28-pin HTSSOP PWP	5962R2120302PYE
	None	Engineering Model <sup>(3)</sup>	14-pin CFP HBL	TPS7H1111HBL/EM
TPS7H1111-SEP	TID of 50 krad(Si) RLAT, DSEE free to 43 MeV-cm <sup>2</sup> /mg	Space Enhanced Plastic	28-pin HTSSOP PWP	TPS7H1111MPWPTSEP
SN0014HBL	N/A	Mechanical "dummy" package (no die)	14-pin CFP HBL	SN0014HBL

- (1) TID is total ionizing dose and DSEE is destructive single event effects. Additional information is available in the associated TID reports and SEE reports for each product.
- (2) For additional information about part grade, view [SLYB235](#).
- (3) These units are intended for engineering evaluation only. They are processed to a non-compliant flow (such as no burn-in and only 25°C testing). These units are not suitable for qualification, production, radiation testing, or flight use. Parts are not warranted as to performance over temperature or operating life.

## 5 Pin Configuration and Functions



**Table 5-1. Pin Functions**

NAME	PIN		I/O <sup>(1)</sup>	DESCRIPTION
	HBL (14) NO.	PWP (28) NO.		
BIAS	1	3	I	Bias supply. To support full output current, a separate bias supply is required if the headroom voltage is less than 1.6 V ( $V_{\text{headroom}} = V_{\text{IN}} - V_{\text{OUT}} < 1.6 \text{ V}$ ). Set the separate bias supply to a voltage at least 1.6 V higher than $V_{\text{OUT}}$ for full output current support. A 12-V bias supply will satisfy these conditions (generally a 5-V supply will also suffice). There are no sequencing requirements between $V_{\text{BIAS}}$ and $V_{\text{IN}}$ . In order to limit noise on BIAS, an RC filter is recommended (typically 10 $\Omega$ and 4.7 $\mu\text{F}$ ) unless $V_{\text{BIAS}}$ is an ultra-clean supply. If a separate bias supply is not used, connect BIAS to $V_{\text{IN}}$ (it is also recommended to connect the $V_{\text{IN}}$ rail to the BIAS pin through an RC filter).
EN	2	4	I	Enable. Driving this pin to logic high enables the device; driving the pin to logic low disables the device. If enable functionality is not required, connect this pin to IN. Do not float this pin.
IN	3, 4	6, 7, 8	I	Input power. An input capacitor (nominally 10 $\mu\text{F}$ ) near this pin is recommended.
CLM	5	9	I	Current limit mode. Connect CLM to $V_{\text{IN}}$ for brick-wall current limit mode (when current limit is reached, $V_{\text{OUT}}$ is regulated to maintain a constant output current until the fault is removed). Connect CLM to GND for turn-off current limit mode (when current limit is reached, $V_{\text{OUT}}$ stops regulating until EN is toggled). Do not change the value of this pin when the device is enabled, and do not float this pin.
GND	6	10, 11	—	Ground.
PG	7	12	O	Power good indicator. This is an open drain pin. Use a pull-up resistor to pull this pin up to $V_{\text{OUT}}$ or the desired logic level. It is recommended to pull down PG to ground if unused but it may be left floating.
REF	8	18	I/O	Reference pin. REF outputs a nominal 1.2 V. Place a high accuracy 12.0-k $\Omega$ external resistor from REF to GND to set the internal 100- $\mu\text{A}$ current source.
SS_SET	9	19	I/O	Soft-start and voltage set pin. An external capacitor (nominally 4.7- $\mu\text{F}$ ceramic) is used to slow down the output voltage ramp rate during startup along with filtering internal device noise. Capacitor values less than 4.7 $\mu\text{F}$ will result in marginally higher output noise. There is internal fast start circuitry to enable reasonable soft start times. Additionally, a resistor from SS_SET to GND sets the output voltage. During nominal operation, 100 $\mu\text{A}$ is output on this pin and a resistor from SS_SET to GND sets the output voltage.
STAB	10	20	I/O	Stability pin. This is an output from the internal OTA (operational transconductance) error amplifier to aid in measuring or optimizing the control loop. Use a series capacitor ( $C_{\text{COMP}}$ ) and resistor ( $R_{\text{COMP}}$ ) of 4.7 nF and 5 k $\Omega$ to compensate the device. For different compensation options, view <a href="#">Section 8.3.8.2</a> . A C0G (NP0) type capacitor capable of withstanding the lower of $V_{\text{BIAS}}$ or 7.5 V is recommended (for example, a 25-V rated capacitor).

**Table 5-1. Pin Functions (continued)**

NAME	PIN		I/O <sup>(1)</sup>	DESCRIPTION
	HBL (14) NO.	PWP (28) NO.		
OUT	11, 12	21, 22, 23	O	Output power pin. The regulated output voltage. A single 220- $\mu$ F or two 100- $\mu$ F tantalum or tantalum polymer capacitors are recommended. See <a href="#">Section 8.3.8.1</a> for additional information.
OUTS	13	25	I	Output sense pin. This pin is used to sense the output voltage for regulation. Connect OUTS to the OUT pin at the desired point of regulation (remote sense).
FB_PG	14	26	I	Feedback and power good pin. The FB_PG pin enables setting of a configurable power good threshold. This is achieved by feeding the output voltage through a resistor divider to this pin (typical threshold of 300 mV). When the threshold is reached, PG is asserted. Additionally, when the threshold on this pin is reached, start-up is over and the internal fast start circuitry is disabled. If this pin is connected directly to OUT, fast start operation ceases and PG is asserted as soon as $V_{OUT}$ reaches 300 mV (typical).
NC		1, 2, 5, 13, 14, 15, 16, 17, 24, 27, 28	—	No connect. This pin is not internally connected. It is recommended to connect these pins to GND to prevent charge buildup; however, these pins can also be left open or tied to any voltage between GND and $V_{BIAS}$ .
Thermal pad			—	The ceramic package thermal pad is internally connected to the backside of the die through an electrically conductive path and to the GND pin. It is recommended to connect this metal thermal pad to a large ground plane for effective heat dissipation. The plastic package thermal pad is connected to the backside of the die through an electrically conductive path, it is not internally grounded. Connect the thermal pad to a large ground plane for effective heat dissipation and to provide a connection of the backside of the die to GND for proper operation.
Metal lid	Lid	N/A	—	The lid is internally connected to the thermal pad and GND through the seal ring.

(1) I = Input, O = Output, I/O = Input or Output, — = Other

## 6 Specifications

### 6.1 Absolute Maximum Ratings

over operating free-air temperature range (unless otherwise noted)<sup>(1)</sup>

		MIN	MAX	UNIT
Input voltage	IN	-0.3	7.5	V
	BIAS	-0.3	16	
	EN, PG, FB_PG, OUTS, CLM	-0.3	7.5	
Output voltage	OUT	-0.3	7.5	V
	SS_SET, REF, STAB	-0.3	7.5	
Input current	PG	-0.001	0.01	A
Output current	OUT	-2	2.25	A
Junction temperature	T <sub>J</sub>	-55	150	°C
Storage temperature	T <sub>stg</sub>	-65	150	°C

- (1) Operation outside the Absolute Maximum Ratings may cause permanent device damage. Absolute Maximum Ratings do not imply functional operation of the device at these or any other conditions beyond those listed under Recommended Operating Conditions. If used outside the Recommended Operating Conditions but within the Absolute Maximum Ratings, the device may not be fully functional, and this may affect device reliability, functionality, performance, and shorten the device lifetime.

### 6.2 ESD Ratings

			VALUE	UNIT
V <sub>(ESD)</sub>	Electrostatic discharge	Human body model (HBM), per ANSI/ESDA/JEDEC JS-001, all pins <sup>(1)</sup>	±2000	V
		Charged device model (CDM), per ANSI/ESDA/JEDEC JS-002, all pins <sup>(2)</sup>	±1000	

- (1) JEDEC document JEP155 states that 500-V HBM allows safe manufacturing with a standard ESD control process.  
 (2) JEDEC document JEP157 states that 250-V CDM allows safe manufacturing with a standard ESD control process.

### 6.3 Recommended Operating Conditions

over operating temperature range,  $T_J = -55^{\circ}\text{C}$  to  $125^{\circ}\text{C}$  (unless otherwise noted)

		MIN	NOM	MAX	UNIT
Input voltage	IN	0.85		7	V
	BIAS <sup>(1)</sup>	$V_{IN}$	$V_{OUT} + 1.6\text{ V}$		
		2.2		14	
	PG	0		7	
	EN	0		7	
	FB_PG	0		6	
CLM	0		$V_{IN}$		
Output voltage	OUT <sup>(2)</sup>			$V_{IN} - V_{DO}$	V
		0.4		5.5	
	SS_SET <sup>(2)</sup>			$V_{IN} - V_{DO}$	
		0.4		5.5	
Input current	PG	0		0.002	A
Output current	OUT	0		1.5	A
Output bulk capacitance <sup>(3)</sup>	C <sub>OUT</sub>	132	200	308	$\mu\text{F}$
	ESR	7		40	m $\Omega$
	ESL	0.8		2.4	nH
Reference configuration	R <sub>REF</sub>	11	12	13	k $\Omega$
EN toggle time <sup>(4)</sup>	t <sub>EN_LOW</sub>	20			$\mu\text{s}$
Junction temperature	T <sub>J</sub>	-55		125	$^{\circ}\text{C}$

- (1) BIAS has two minimum values,  $V_{IN}$  and 2.2 V. BIAS must be set greater than or equal to the larger of these two values. The BIAS max value is always 14 V. For full performance set  $V_{BIAS} \geq V_{OUT} + 1.6\text{ V}$ . See the [Bias Supply Section](#) for further details.
- (2) OUT and SS\_SET have two maximum values,  $(V_{IN} - V_{DO})$  and 5.5 V. OUT and SS\_SET must be set to less than or equal to the smaller of these two values. The OUT and SS\_SET min value is always 0.4 V.
- (3) These are the default acceptable output capacitance, equivalent series resistance (ESR), and equivalent series inductance (ESL) values for the bulk capacitance. Other values may be acceptable, such as by modifying the control loop with external compensation using the STAB pin. Tantalum or Tantalum Polymer capacitors are normally used to meet these requirements. Additional ceramic decoupling capacitors are not required, but a single 0.1  $\mu\text{F}$  ceramic capacitor with low ESL near the point of load is acceptable. Additional larger ceramic capacitors are not needed due to the high PSRR and low noise provided by the TPS7H1111 LDO across a wide bandwidth. Therefore, the TPS7H1111 is not designed to support larger ceramic capacitors. See the [Output Capacitance Section](#) for additional information.
- (4) t<sub>EN\_LOW</sub> is the time the EN pin must be driven low before again being driven high for the device to detect a reset. This is generally only applicable when attempting to exit turn-off current limit mode.

### 6.4 Thermal Information

THERMAL METRIC <sup>(1)</sup>		TPS7H1111-SP	TPS7H1111-SEP	TPS7H1111-SP	UNIT
		CFP HBL	PWP (HTSSOP)	PWP (HTSSOP)	
		14 PINS	28 PINS	28 PINS	
R <sub>θJA</sub>	Junction-to-ambient thermal resistance	25.1	24.7	24.4	$^{\circ}\text{C}/\text{W}$
R <sub>θJC(top)</sub>	Junction-to-case (top) thermal resistance	6.3	15.6	15.8	$^{\circ}\text{C}/\text{W}$
R <sub>θJB</sub>	Junction-to-board thermal resistance	9.3	6.6	6.4	$^{\circ}\text{C}/\text{W}$
Ψ <sub>JT</sub>	Junction-to-top characterization parameter	1.4	0.2	0.2	$^{\circ}\text{C}/\text{W}$
Ψ <sub>JB</sub>	Junction-to-board characterization parameter	9.1	6.6	6.4	$^{\circ}\text{C}/\text{W}$
R <sub>θJC(bot)</sub>	Junction-to-case (bottom) thermal resistance	0.5	1.0	0.7	$^{\circ}\text{C}/\text{W}$

- (1) For more information about traditional and new thermal metrics, see the [Semiconductor and IC Package Thermal Metrics](#) application report.

## 6.5 Electrical Characteristics

Over  $0.85\text{ V} \leq V_{IN} \leq 7\text{ V}$ ,  $V_{BIAS} \geq V_{OUT} + 1.6\text{ V}$  ( $V_{IN} \leq V_{BIAS} \leq 14\text{ V}$  &  $V_{BIAS} \geq 2.2\text{ V}$ ),  $V_{OUT}$  (target)  $\leq V_{IN} - 1.6\text{ V}$ ,  $I_{OUT} = 1\text{ mA}$ ,  $C_{OUT} = 220\text{ }\mu\text{F}^{(1)}$ ,  $R_{REF} = 12.0\text{ k}\Omega$ , over operating temperature range ( $T_A = -55^\circ\text{C}$  to  $125^\circ\text{C}$ ), typical values are at  $T_A = 25^\circ\text{C}$ , unless otherwise noted; includes RLAT at  $T_A = 25^\circ\text{C}$  if sub-group number is present for QML RHA and SEP devices<sup>(2)</sup>

PARAMETER		TEST CONDITIONS		SUB-GROUP <sup>(3)</sup>	MIN	TYP	MAX	UNIT
<b>POWER SUPPLIES AND CURRENTS</b>								
V <sub>DO</sub>	Dropout voltage with $V_{BIAS} \geq V_{OUT} + 1.6\text{ V}$	$0.85\text{ V} \leq V_{IN} \leq 7\text{ V}$ , $V_{OUT} = 98.5\% \times V_{OUT(NOM)}$	$I_{OUT} = 0.1\text{ A}$	1, 2, 3		17	40	mV
			$I_{OUT} = 0.5\text{ A}$	1, 2, 3		75	150	
			$I_{OUT} = 1\text{ A}$	1, 2, 3		110	280	
			$I_{OUT} = 1.5\text{ A}$	1, 2, 3		215	430	
V <sub>DO</sub>	Dropout voltage with $V_{BIAS} = V_{IN}$	$2.2\text{ V} \leq V_{IN} \leq 7\text{ V}$ , $V_{OUT} = 98.5\% \times V_{OUT(NOM)}$	$I_{OUT} = 0.1\text{ A}$	1, 2, 3		785	1100	mV
			$I_{OUT} = 0.5\text{ A}$	1, 2, 3		908	1150	
			$I_{OUT} = 1\text{ A}$	1, 2, 3		1063	1250	
			$I_{OUT} = 1.5\text{ A}$	1, 2, 3		1168	1400	
I <sub>LIM</sub>	Output current limit	$2.5\text{ V} \leq V_{IN} \leq 7\text{ V}$ $V_{OUT} = 0.5\text{ V}$ , $V_{CLM} = V_{IN}$	$T_A = -55^\circ\text{C}$	3	1.8	1.95	2.1	A
			$T_A = 25^\circ\text{C}$	1	1.75	1.85	2	
			$T_A = 125^\circ\text{C}$	2	1.7	1.8	1.95	
I <sub>CLM(LKG)</sub>	CLM input leakage current	$V_{CLM} = 7\text{ V}$		1, 2, 3		5	150	nA
I <sub>Q_IN</sub>	Quiescent current	$V_{EN} = 7\text{ V}$ , $I_{OUT} = 0\text{ A}$		1, 2, 3		19	27	mA
I <sub>Q_BIAS</sub>	Bias current with no output load	$V_{EN} = 7\text{ V}$ , $I_{OUT} = 0\text{ A}$		1, 2, 3		16	25	
I <sub>IN_GND</sub>	$I_{IN} - I_{OUT}$ with full output load	$V_{EN} = 7\text{ V}$ , $I_{OUT} = 1.5\text{ A}$		1, 2, 3		20	27	mA
I <sub>BIAS</sub>	Bias current with full output load	$V_{EN} = 7\text{ V}$ , $I_{OUT} = 1.5\text{ A}$		1, 2, 3		17	25	
I <sub>SHDN</sub>	Shutdown current	$V_{EN} = 0\text{ V}$ , $I_{OUT} = 0\text{ A}$ , $V_{OUT} = 0\text{ V}$		1, 2, 3		20	350	$\mu\text{A}$
I <sub>SHDN_BIAS</sub>	Shutdown bias current	$V_{EN} = 0\text{ V}$ , $I_{OUT} = 0\text{ A}$ , $V_{OUT} = 0\text{ V}$		1, 2, 3		550	1000	
<b>ACCURACY</b>								
V <sub>ACC</sub>	Output voltage accuracy	$1\text{ mA} \leq I_{OUT} \leq 1.5\text{ A}$ , $2.2\text{ V} \leq V_{BIAS} \leq 14\text{ V}^{(4)}$ , $P_D \leq 4\text{ W}^{(5)}$	$-55^\circ\text{C} \leq T_A \leq 125^\circ\text{C}$	1, 2, 3	-1.3%		1.2%	
			$T_A = -55^\circ\text{C}$	3	-1.3%		0.5%	
			$T_A = 25^\circ\text{C}$	1	-0.7%		0.9%	
			$T_A = 25^\circ\text{C}$ , post TID <sup>(6)</sup>	1	-0.7%		1.1%	
			$T_A = 125^\circ\text{C}$	2	-0.7%		1.2%	
I <sub>SET</sub>	SS_SET pin current to set $V_{OUT}$	$-55^\circ\text{C} \leq T_A \leq 125^\circ\text{C}$	$T_A = -55^\circ\text{C}$	3	98.8	99.4	100.3	$\mu\text{A}$
			$T_A = 25^\circ\text{C}$	1	99.0	100	100.9	
			$T_A = 125^\circ\text{C}$	2	99.2	100.2	101	
				1, 2, 3	98.8	99.9	101	
V <sub>OS</sub>	Output offset voltage ( $V_{OUT} - V_{SS\_SET}$ )	$-55^\circ\text{C} \leq T_A \leq 125^\circ\text{C}$	$T_A = -55^\circ\text{C}$	3	-1.33	-0.2	0.78	mV
			$T_A = 25^\circ\text{C}$	1	-1.45	-0.25	0.76	
			$T_A = 25^\circ\text{C}$ , post TID <sup>(6)</sup>	1	-1.45		1.5	
			$T_A = 125^\circ\text{C}$	2	-2	-0.5	0.7	
				1, 2, 3	-2		0.78	
V <sub>OUTtempco</sub>	$V_{OUT}$ temperature coefficient	$T_A$ from $-55^\circ\text{C}$ to $125^\circ\text{C}$				0.004%	$V_{OUT}/^\circ\text{C}$	
		$T_A$ from $-55^\circ\text{C}$ to $-40^\circ\text{C}$				0.011%		
		$T_A$ from $-40^\circ\text{C}$ to $0^\circ\text{C}$				0.007%		
		$T_A$ from $0^\circ\text{C}$ to $25^\circ\text{C}$				0.005%		
		$T_A$ from $25^\circ\text{C}$ to $85^\circ\text{C}$				0.003%		
		$T_A$ from $85^\circ\text{C}$ to $125^\circ\text{C}$				0.001%		

## 6.5 Electrical Characteristics (continued)

Over  $0.85\text{ V} \leq V_{IN} \leq 7\text{ V}$ ,  $V_{BIAS} \geq V_{OUT} + 1.6\text{ V}$  ( $V_{IN} \leq V_{BIAS} \leq 14\text{ V}$  &  $V_{BIAS} \geq 2.2\text{ V}$ ),  $V_{OUT}$  (target)  $\leq V_{IN} - 1.6\text{ V}$ ,  $I_{OUT} = 1\text{ mA}$ ,  $C_{OUT} = 220\text{ }\mu\text{F}$ <sup>(1)</sup>,  $R_{REF} = 12.0\text{ k}\Omega$ , over operating temperature range ( $T_A = -55^\circ\text{C}$  to  $125^\circ\text{C}$ ), typical values are at  $T_A = 25^\circ\text{C}$ , unless otherwise noted; includes RLAT at  $T_A = 25^\circ\text{C}$  if sub-group number is present for QML RHA and SEP devices<sup>(2)</sup>

PARAMETER		TEST CONDITIONS		SUB-GROUP <sup>(3)</sup>	MIN	TYP	MAX	UNIT
$V_{REF}$	Reference voltage, ceramic package			1, 2, 3	1.191	1.206	1.220	V
$V_{REF}$	Reference voltage, plastic package			1, 2, 3	1.190	1.206	1.221	
$\Delta V_{OUT}/\Delta V_{IN}$	Line regulation, see <a href="#">Figure 7-1</a>	$0.85\text{ V} \leq V_{IN} \leq 7\text{ V}$ , $I_{OUT} = 1\text{ mA}$ , $V_{BIAS} = 5\text{ V}$ , $V_{OUT} = 0.4\text{ V}$		1, 2, 3		3	200	$\mu\text{V}/\text{V}$
$\Delta V_{OUT}/\Delta I_{OUT}$	Load regulation, see <a href="#">Figure 7-2</a>	$1\text{ mA} \leq I_{OUT} \leq 1.5\text{ A}$ , $V_{BIAS} = 5\text{ V}$ , $V_{IN} = 2.5\text{ V}$ , $V_{OUT} = 1.8\text{ V}$		1, 2, 3		500	1000	$\mu\text{V}/\text{A}$
	Current sharing error percentage	$R_{ballast} = 5\text{ m}\Omega$ , $T_A = 25^\circ\text{C}$	$I_{OUT(TOTAL)} = 1.2\text{ A}$			$\pm 1\%$		
			$I_{OUT(TOTAL)} = 2.9\text{ A}$			$\pm 0.1\%$		
$I_{OUTS(LKG)}$	OUTS leakage current			1, 2, 3		20	200	nA
<b>ENABLE</b>								
$V_{EN(rising)}$	Enable rising threshold (turn-on)			1, 2, 3	0.58	0.60	0.62	V
$V_{EN(falling)}$	Enable falling threshold (turn-off)			1, 2, 3	0.48	0.50	0.52	
$t_{EN(delay)}$	EN propagation delay	EN high to $V_{OUT} = 10\text{ mV}$		9, 10, 11		90	500	$\mu\text{s}$
$I_{EN(LKG)}$	Enable input leakage current	$V_{EN} = 7\text{ V}$		1, 2, 3		3	150	nA
$T_{SD(enter)}$	Thermal shutdown enter					160		$^\circ\text{C}$
$T_{SD(exit)}$	Thermal shutdown exit					130		
<b>POWER GOOD</b>								
$V_{FB\_PG(rising)}$	Power good rising threshold			1, 2, 3	290	306	313	mV
$V_{FB\_PG(HYS)}$	Power good hysteresis			1, 2, 3	7	14	19	
$I_{FB\_PG(LKG)}$	FB_PG input leakage current	$V_{FB\_PG} = 6\text{ V}$		1, 2, 3		9	150	nA
$V_{PG(OL)}$	Power good output low	$I_{PG(SINK)} = 2\text{ mA}$		1, 2, 3		113	200	mV
$V_{IN(MIN\_PG)}$	Minimum $V_{IN}$ or $V_{BIAS}$ for valid PG ( $V_{PG} < 0.5\text{ V}$ )	$I_{PG(sink)} = 0.6\text{ mA}$		1, 2, 3		0.6	0.8	V
$I_{PG(LKG)}$	Power good leakage	$V_{PG} = 7\text{ V}$ , $V_{FB\_PG} > V_{FB\_PG(rising\ threshold)}$		1, 2, 3		0.1	2	$\mu\text{A}$
<b>SOFT START</b>								
$I_{SS\_SET(start)}$	SS_SET pin current during startup			1, 2, 3	1.68	2.1	2.52	mA
$t_{SS}$	Soft-start time	$V_{IN} = 2.5\text{ V}$ , $V_{OUT} = 1.8\text{ V}$ , $I_{OUT} = 1\text{ A}$ , $R_{FB\_PG(top)} = 44.2\text{ k}\Omega$ , $R_{FB\_PG(bot)} = 10\text{ k}\Omega$		$C_{SS} = 2.2\text{ }\mu\text{F}$			1.7	ms
				$C_{SS} = 4.7\text{ }\mu\text{F}$			3.7	
				$C_{SS} = 10\text{ }\mu\text{F}$			7.8	
<b>NOISE AND PSRR</b>								
PSRR	Power-supply rejection ratio	$V_{IN} = 2.5\text{ V}$ , $V_{OUT} = 1.8\text{ V}$ , $V_{BIAS} = 5\text{ V}$ , $I_{OUT} = 1\text{ A}$ , $C_{SS} = 4.7\text{ }\mu\text{F}$ , $C_{BIAS} = 4.7\text{ }\mu\text{F}$ , $R_{BIAS} = 10\text{ }\Omega$		$f_{ripple} = 100\text{ Hz}$			109	dB
				$f_{ripple} = 1\text{ kHz}$			109	
				$f_{ripple} = 10\text{ kHz}$			90	
				$f_{ripple} = 100\text{ kHz}$			71	
				$f_{ripple} = 1\text{ MHz}$			66	
				$f_{ripple} = 10\text{ MHz}$			30	

## 6.5 Electrical Characteristics (continued)

Over  $0.85\text{ V} \leq V_{IN} \leq 7\text{ V}$ ,  $V_{BIAS} \geq V_{OUT} + 1.6\text{ V}$  ( $V_{IN} \leq V_{BIAS} \leq 14\text{ V}$  &  $V_{BIAS} \geq 2.2\text{ V}$ ),  $V_{OUT}$  (target)  $\leq V_{IN} - 1.6\text{ V}$ ,  $I_{OUT} = 1\text{ mA}$ ,  $C_{OUT} = 220\text{ }\mu\text{F}$ <sup>(1)</sup>,  $R_{REF} = 12.0\text{ k}\Omega$ , over operating temperature range ( $T_A = -55^\circ\text{C}$  to  $125^\circ\text{C}$ ), typical values are at  $T_A = 25^\circ\text{C}$ , unless otherwise noted; includes RLAT at  $T_A = 25^\circ\text{C}$  if sub-group number is present for QML RHA and SEP devices<sup>(2)</sup>

PARAMETER		TEST CONDITIONS		SUB-GROUP <sup>(3)</sup>	MIN	TYP	MAX	UNIT
PSRR <sub>BIAS</sub>	Power-supply rejection ratio, $V_{BIAS}$ to $V_{OUT}$	$V_{IN} = 2.5\text{ V}$ , $V_{OUT} = 1.8\text{ V}$ , $V_{BIAS} = 5\text{ V}$ , $I_{OUT} = 1\text{ A}$ , $C_{SS} = 4.7\text{ }\mu\text{F}$ , $C_{BIAS} = 4.7\text{ }\mu\text{F}$ , $R_{BIAS} = 10\text{ }\Omega$	$f_{\text{ripple}} = 100\text{ Hz}$			102		dB
			$f_{\text{ripple}} = 1\text{ kHz}$			105		
			$f_{\text{ripple}} = 10\text{ kHz}$			87		
			$f_{\text{ripple}} = 100\text{ kHz}$			97		
			$f_{\text{ripple}} = 1\text{ MHz}$			118		
			$f_{\text{ripple}} = 10\text{ MHz}$			68		
$V_N$	Output noise rms voltage (Bandwidth from 10 Hz to 100 kHz)	$V_{IN} = 2.5\text{ V}$ , $V_{OUT} = 1.8\text{ V}$ , $V_{BIAS} = 5\text{ V}$ , $I_{OUT} = 1\text{ A}$	$C_{SS} = 2.2\text{ }\mu\text{F}$			1.73		$\mu\text{V}_{\text{RMS}}$
			$C_{SS} = 4.7\text{ }\mu\text{F}$			1.71		
			$C_{SS} = 10\text{ }\mu\text{F}$			1.69		
$e_N$	Output noise voltage density	$V_{IN} = 2.5\text{ V}$ , $V_{OUT} = 1.8\text{ V}$ , $V_{BIAS} = 5\text{ V}$ , $I_{OUT} = 1\text{ A}$ , $C_{SS} = 4.7\text{ }\mu\text{F}$	$f = 10\text{ Hz}$			97		nV/ $\sqrt{\text{Hz}}$
			$f = 100\text{ Hz}$			11.2		
			$f = 1\text{ kHz}$			5.4		
			$f = 10\text{ kHz}$			5.6		
			$f = 100\text{ kHz}$			4.9		
			$f = 1\text{ MHz}$			1.6		
			$f = 10\text{ MHz}$			1.7		
<b>STABILITY</b>								
PM	Phase margin	$V_{IN} = 2.5\text{ V}$ , $V_{OUT} = 1.8\text{ V}$ , $I_{OUT} = 1.0\text{ A}$ , $C_{OUT} = 2 \times 100\text{ }\mu\text{F}$ <sup>(7)</sup>				98°		
GM	Gain margin					19		dB

(1) A single 220  $\mu\text{F}$  tantalum capacitor is utilized

(2) See the [5962R21203](#) SMD for additional information on the QML RHA devices and see the [V62/23602](#) VID for additional information on the SEP devices.

(3) The subgroups are only applicable for QML versions of the device; for subgroup definitions, see [Section 6.6](#).

(4) Additionally,  $V_{BIAS} \geq V_{IN}$  and  $V_{BIAS} \geq V_{OUT} + 1.6\text{ V}$ .

(5)  $P_D$  is the internal power dissipation. When  $P_D$  exceeds 4 W, the current is lowered to avoid excessive local heating (due to tester limitations).

(6) TID = 100 krad(Si) for QMLV and QMLP parts and TID = 50 krad(Si) for SEP parts.

(7) See [Section 9.3](#) for additional information.

## 6.6 Quality Conformance Inspection

MIL-STD-883, Method 5005 - Group A

SUBGROUP	DESCRIPTION	TEMPERATURE (°C)
1	Static tests at	25
2	Static tests at	125
3	Static tests at	-55
4	Dynamic tests at	25
5	Dynamic tests at	125
6	Dynamic tests at	-55
7	Functional tests at	25
8A	Functional tests at	125
8B	Functional tests at	-55
9	Switching tests at	25
10	Switching tests at	125
11	Switching tests at	-55

## 6.7 Typical Characteristics

$V_{IN} = 2.5\text{ V}$ ,  $V_{OUT} = 1.8\text{ V}$ ,  $V_{BIAS} = 5\text{ V}$ ,  $I_{OUT} = 1\text{ A}$ ,  $C_{OUT} = 2 \times 100\text{ }\mu\text{F}$ ,  $C_{SS} = 4.7\text{ }\mu\text{F}$ ,  $R_{REF} = 12.0\text{ k}\Omega$ ,  $R_{BIAS} = 10\text{ }\Omega$ ,  $C_{BIAS} = 4.7\text{ }\mu\text{F}$ ,  $T_A = 25^\circ\text{C}$ , unless otherwise noted, integrated noise reported with 10-Hz to 100-kHz bandwidth.

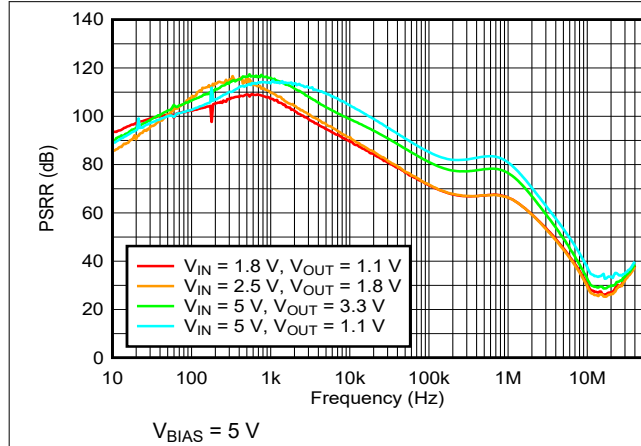


Figure 6-1. PSRR vs Frequency (Common Configurations)

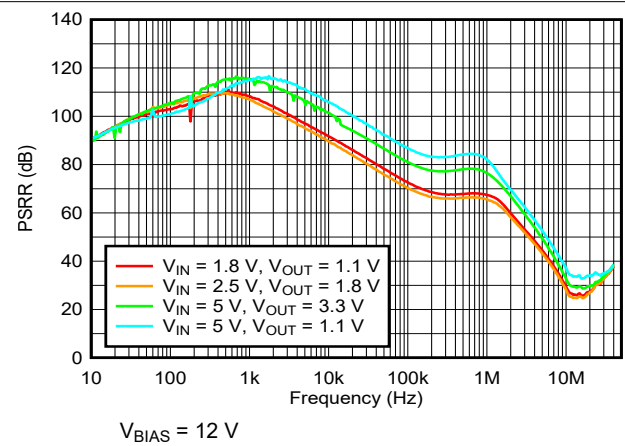


Figure 6-2. PSRR vs Frequency (Common Configurations)

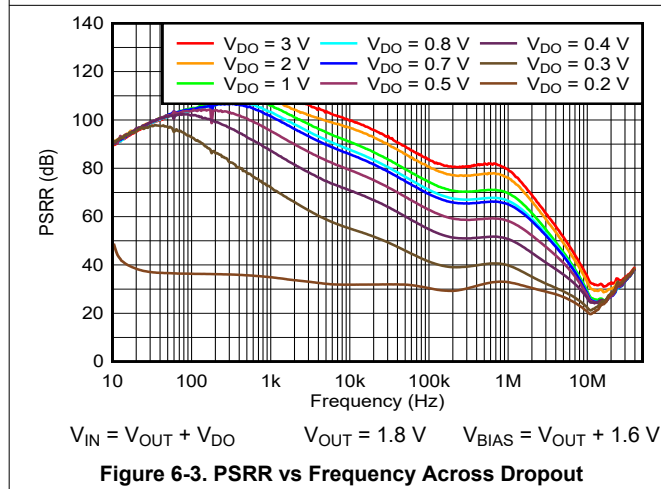


Figure 6-3. PSRR vs Frequency Across Dropout

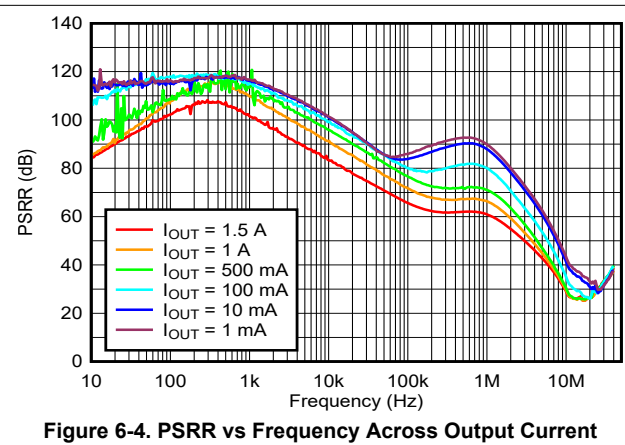


Figure 6-4. PSRR vs Frequency Across Output Current

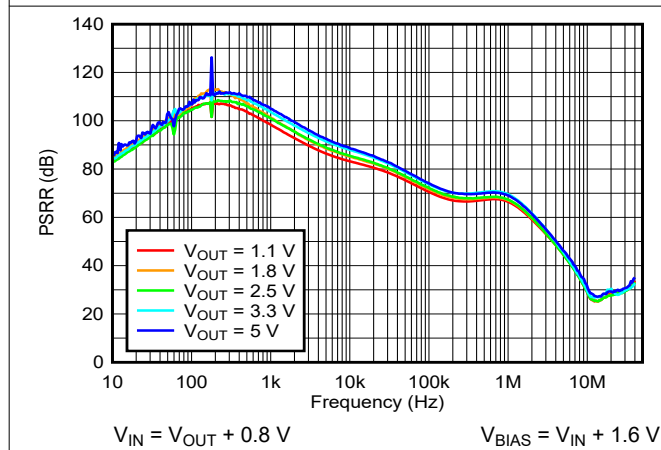


Figure 6-5. PSRR vs Frequency Across Output Voltage

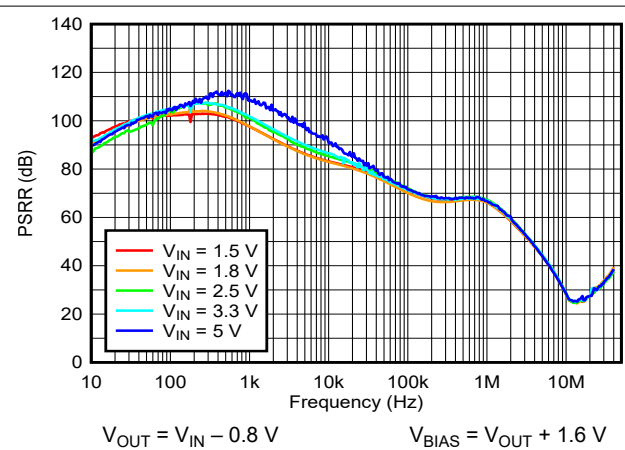
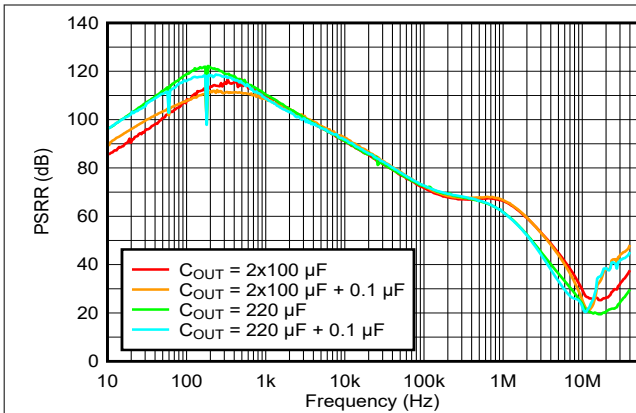


Figure 6-6. PSRR vs Frequency Across Input Voltage

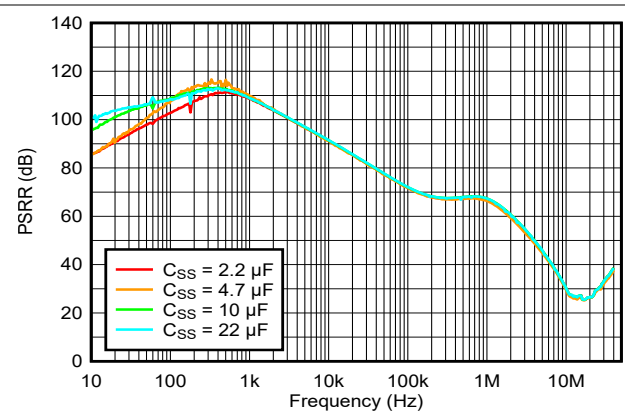
### 6.7 Typical Characteristics (continued)

$V_{IN} = 2.5\text{ V}$ ,  $V_{OUT} = 1.8\text{ V}$ ,  $V_{BIAS} = 5\text{ V}$ ,  $I_{OUT} = 1\text{ A}$ ,  $C_{OUT} = 2 \times 100\ \mu\text{F}$ ,  $C_{SS} = 4.7\ \mu\text{F}$ ,  $R_{REF} = 12.0\ \text{k}\Omega$ ,  $R_{BIAS} = 10\ \Omega$ ,  $C_{BIAS} = 4.7\ \mu\text{F}$ ,  $T_A = 25^\circ\text{C}$ , unless otherwise noted, integrated noise reported with 10-Hz to 100-kHz bandwidth.

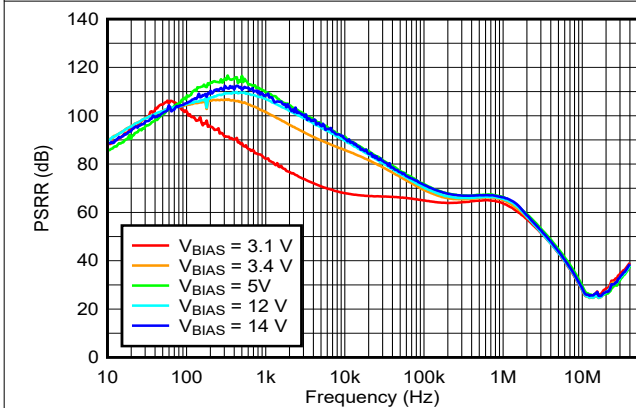


See Table 9-4 for capacitor part numbers utilized.

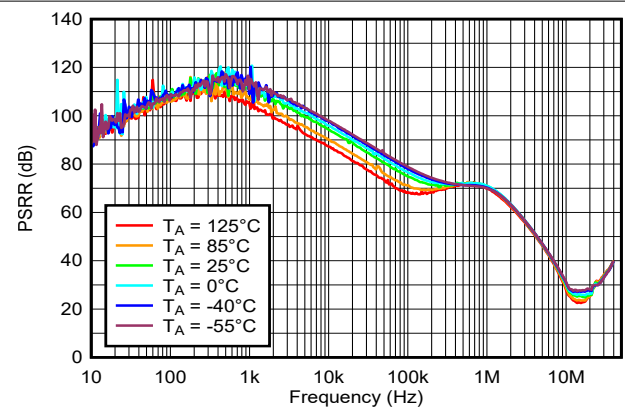
**Figure 6-7. PSRR vs Frequency Across Output Capacitors**



**Figure 6-8. PSRR vs Frequency Across Soft Start Capacitance**

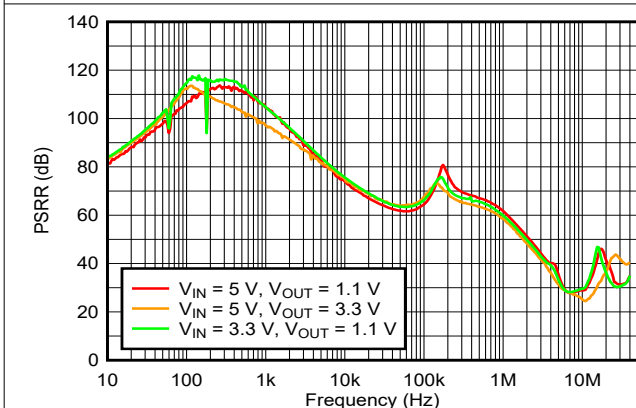


**Figure 6-9. PSRR vs Frequency Across Bias Supply**



$I_{OUT} = 500\text{ mA}$

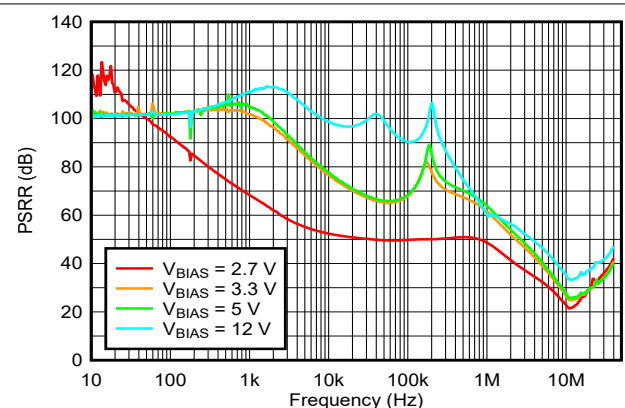
**Figure 6-10. PSRR vs Frequency Across Temperature**



$R_{BIAS} = 0\ \Omega$

$C_{BIAS} = 0\ \mu\text{F}$

**Figure 6-11. PSRR vs Frequency With  $V_{IN} = V_{BIAS}$**

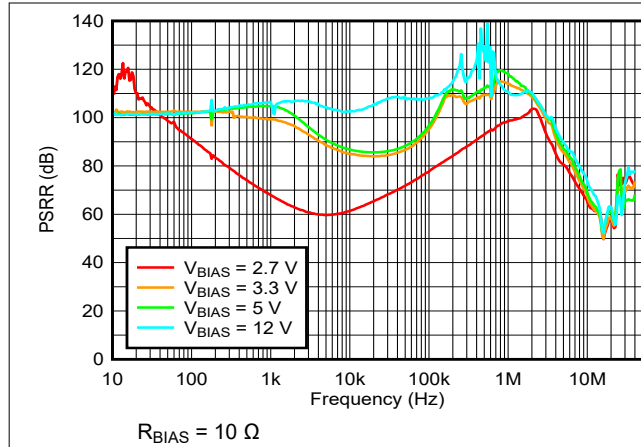


$R_{BIAS} = 0\ \Omega$

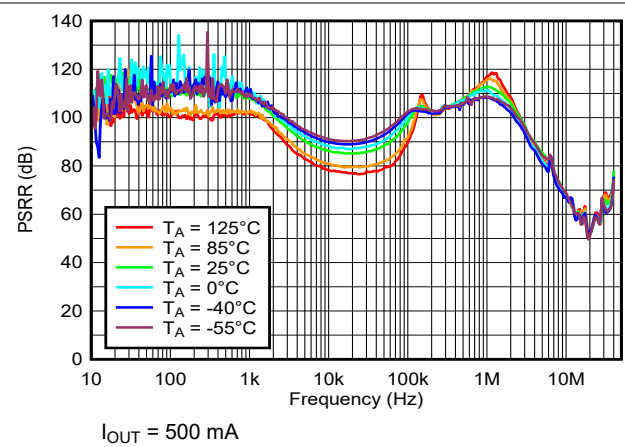
**Figure 6-12. PSRR<sub>BIAS</sub> vs Frequency Across Bias Voltage Without RC**

### 6.7 Typical Characteristics (continued)

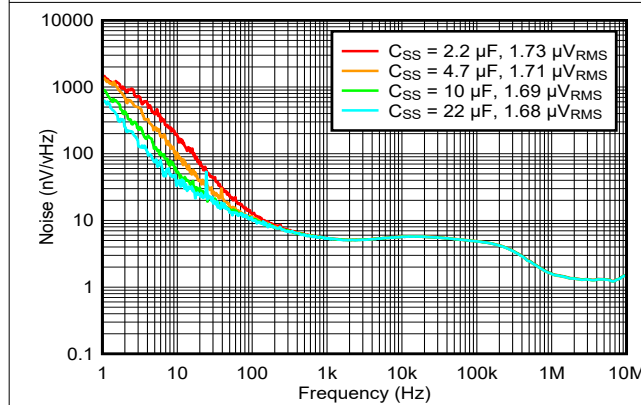
$V_{IN} = 2.5\text{ V}$ ,  $V_{OUT} = 1.8\text{ V}$ ,  $V_{BIAS} = 5\text{ V}$ ,  $I_{OUT} = 1\text{ A}$ ,  $C_{OUT} = 2 \times 100\ \mu\text{F}$ ,  $C_{SS} = 4.7\ \mu\text{F}$ ,  $R_{REF} = 12.0\ \text{k}\Omega$ ,  $R_{BIAS} = 10\ \Omega$ ,  $C_{BIAS} = 4.7\ \mu\text{F}$ ,  $T_A = 25^\circ\text{C}$ , unless otherwise noted, integrated noise reported with 10-Hz to 100-kHz bandwidth.



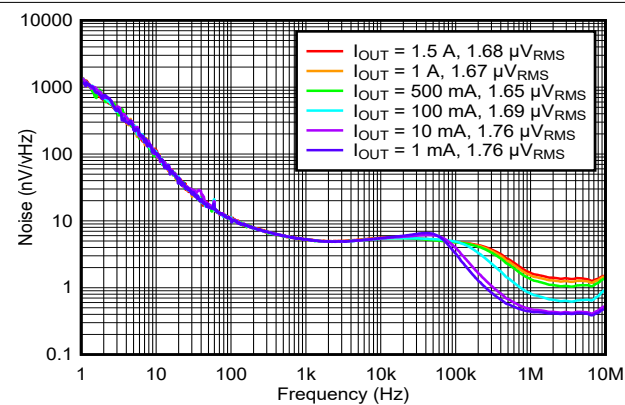
**Figure 6-13. PSRR<sub>BIAS</sub> vs Frequency Across Bias Voltage With RC**



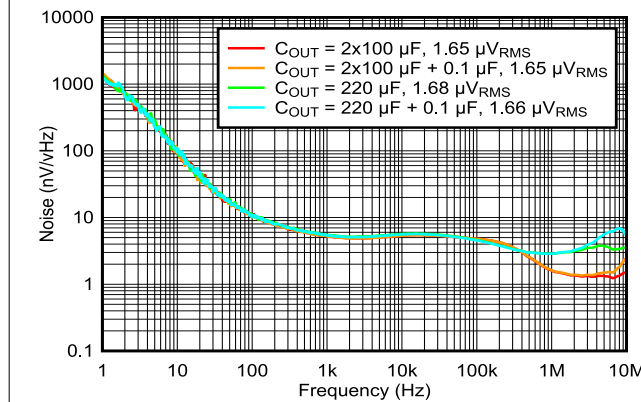
**Figure 6-14. PSRR<sub>BIAS</sub> vs Frequency Across Temperature**



**Figure 6-15. Output Noise vs Frequency Across C<sub>SS</sub> (Noise Spectral Density)**

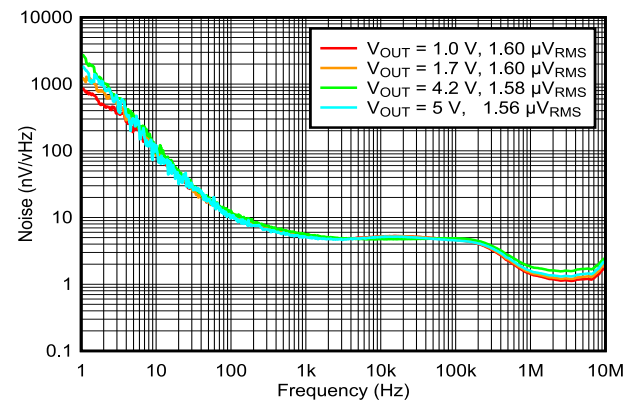


**Figure 6-16. Output Noise vs Frequency Across Output Current (Noise Spectral Density)**



See Table 9-4 for capacitor part numbers utilized.

**Figure 6-17. Output Noise vs Frequency Across Output Capacitor (Noise Spectral Density)**

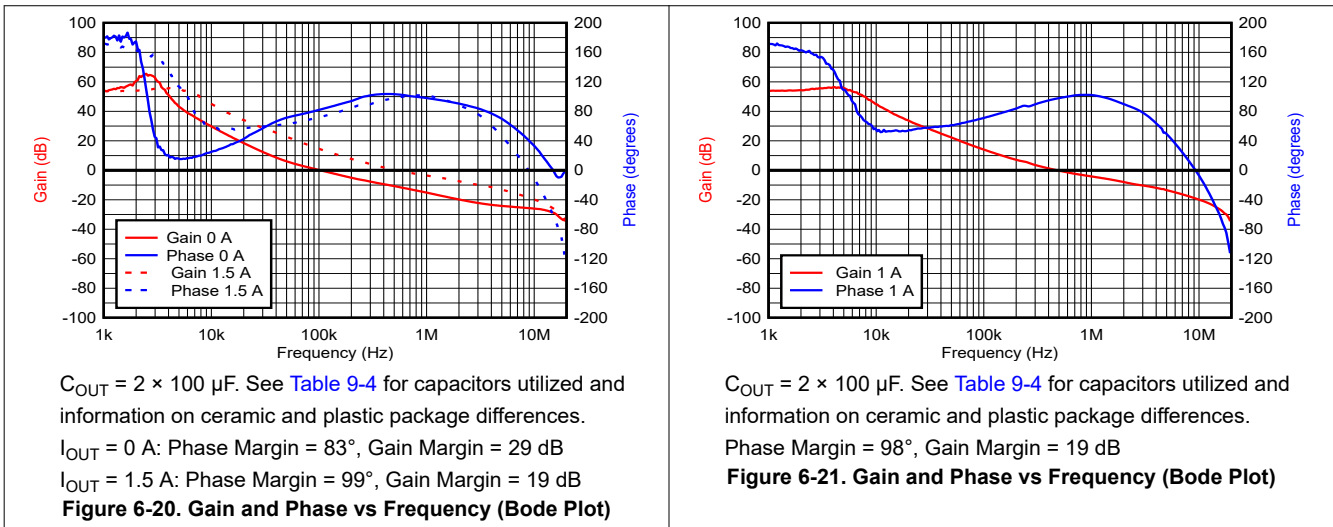
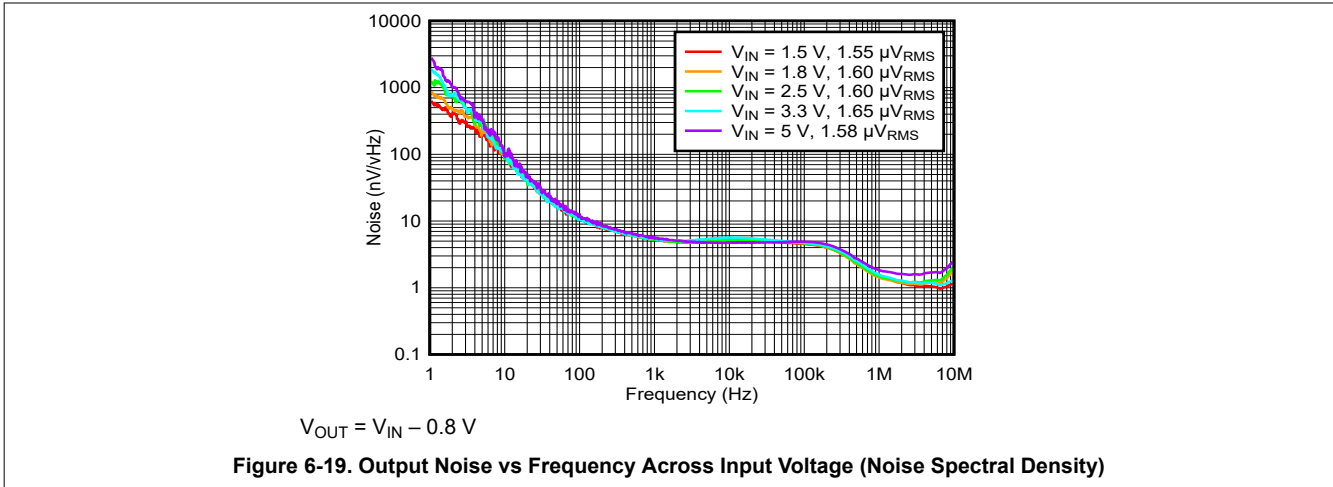


$V_{IN} = V_{OUT} + 0.8\text{ V}$

**Figure 6-18. Output Noise vs Frequency Across Output Voltage (Noise Spectral Density)**

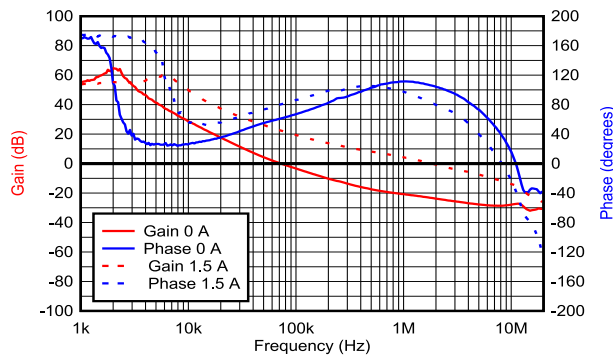
### 6.7 Typical Characteristics

$V_{IN} = 2.5\text{ V}$ ,  $V_{OUT} = 1.8\text{ V}$ ,  $V_{BIAS} = 5\text{ V}$ ,  $I_{OUT} = 1\text{ A}$ ,  $C_{OUT} = 2 \times 100\ \mu\text{F}$ ,  $C_{SS} = 4.7\ \mu\text{F}$ ,  $R_{REF} = 12.0\ \text{k}\Omega$ ,  $R_{BIAS} = 10\ \Omega$ ,  $C_{BIAS} = 4.7\ \mu\text{F}$ ,  $T_A = 25^\circ\text{C}$ , unless otherwise noted, integrated noise reported with 10-Hz to 100-kHz bandwidth.



## 6.7 Typical Characteristics (continued)

$V_{IN} = 2.5\text{ V}$ ,  $V_{OUT} = 1.8\text{ V}$ ,  $V_{BIAS} = 5\text{ V}$ ,  $I_{OUT} = 1\text{ A}$ ,  $C_{OUT} = 2 \times 100\text{ }\mu\text{F}$ ,  $C_{SS} = 4.7\text{ }\mu\text{F}$ ,  $R_{REF} = 12.0\text{ k}\Omega$ ,  $R_{BIAS} = 10\text{ }\Omega$ ,  $C_{BIAS} = 4.7\text{ }\mu\text{F}$ ,  $T_A = 25^\circ\text{C}$ , unless otherwise noted, integrated noise reported with 10-Hz to 100-kHz bandwidth.

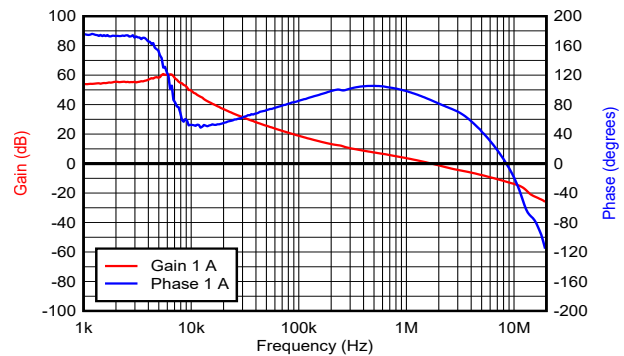


$C_{OUT} = 2 \times 100\text{ }\mu\text{F} + 0.1\text{ }\mu\text{F}$ . See [Table 9-4](#) for capacitors utilized and information on ceramic and plastic package differences.

$I_{OUT} = 0\text{ A}$ : Phase Margin =  $61^\circ$ , Gain Margin = 27 dB

$I_{OUT} = 1.5\text{ A}$ : Phase Margin =  $99^\circ$ , Gain Margin = 12 dB

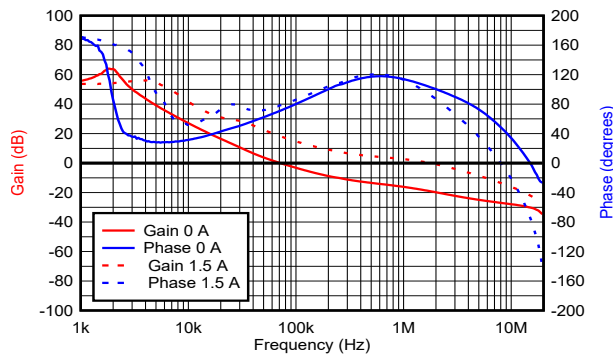
**Figure 6-22. Gain and Phase vs Frequency (Bode Plot)**



$C_{OUT} = 2 \times 100\text{ }\mu\text{F} + 0.1\text{ }\mu\text{F}$ . See [Table 9-4](#) for capacitors utilized and information on ceramic and plastic package differences.

Phase Margin =  $98^\circ$ , Gain Margin = 13 dB

**Figure 6-23. Gain and Phase vs Frequency (Bode Plot)**

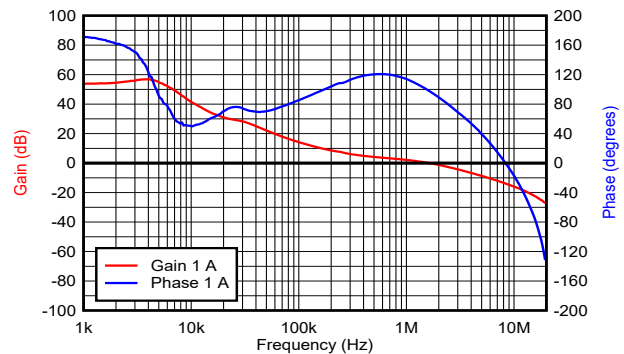


$C_{OUT} = 1 \times 220\text{ }\mu\text{F}$ . See [Table 9-4](#) for capacitors utilized and information on ceramic and plastic package differences.

$I_{OUT} = 0\text{ A}$ : Phase Margin =  $71^\circ$ , Gain Margin = 30 dB

$I_{OUT} = 1.5\text{ A}$ : Phase Margin =  $91^\circ$ , Gain Margin = 14 dB

**Figure 6-24. Gain and Phase vs Frequency (Bode Plot)**



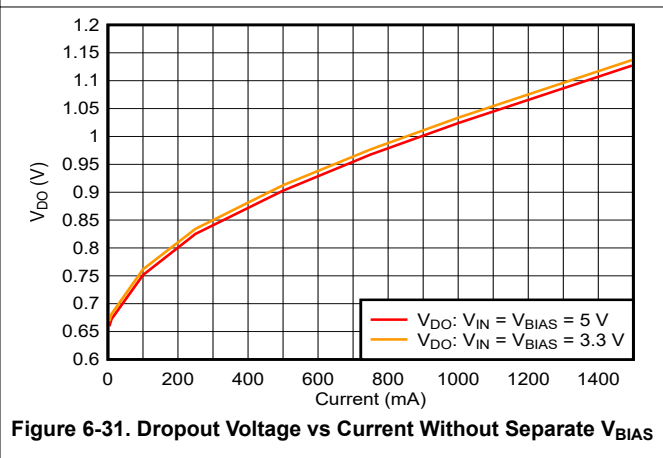
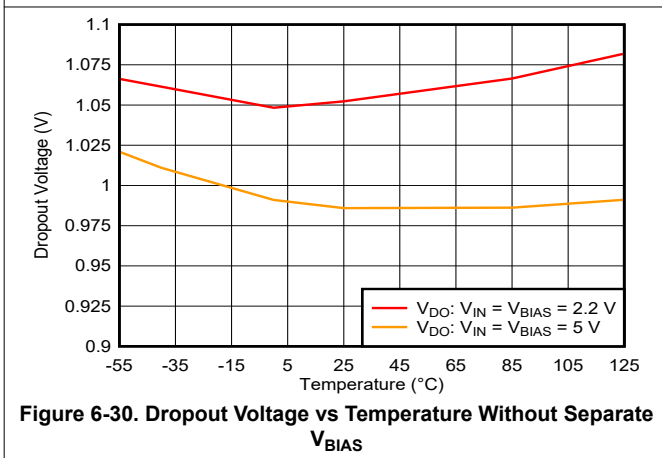
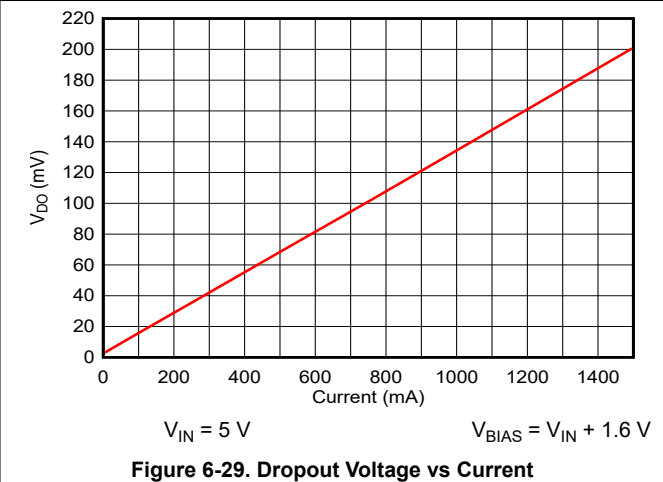
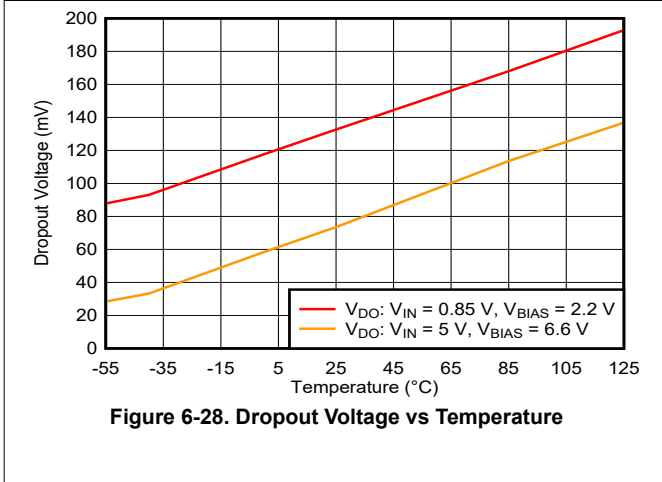
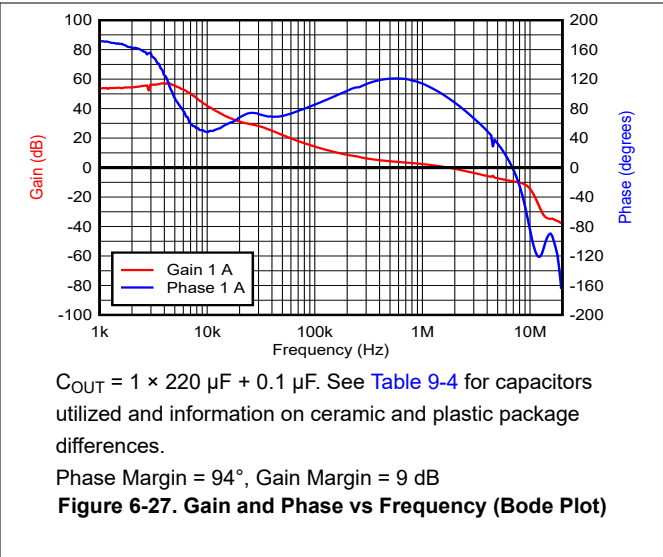
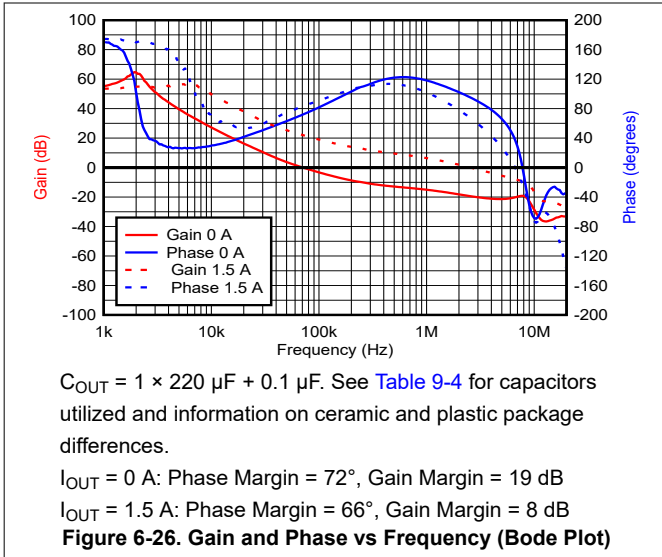
$C_{OUT} = 1 \times 220\text{ }\mu\text{F}$ . See [Table 9-4](#) for capacitors utilized and information on ceramic and plastic package differences.

Phase Margin =  $98^\circ$ , Gain Margin = 14 dB

**Figure 6-25. Gain and Phase vs Frequency (Bode Plot)**

### 6.7 Typical Characteristics (continued)

$V_{IN} = 2.5\text{ V}$ ,  $V_{OUT} = 1.8\text{ V}$ ,  $V_{BIAS} = 5\text{ V}$ ,  $I_{OUT} = 1\text{ A}$ ,  $C_{OUT} = 2 \times 100\text{ }\mu\text{F}$ ,  $C_{SS} = 4.7\text{ }\mu\text{F}$ ,  $R_{REF} = 12.0\text{ k}\Omega$ ,  $R_{BIAS} = 10\text{ }\Omega$ ,  $C_{BIAS} = 4.7\text{ }\mu\text{F}$ ,  $T_A = 25^\circ\text{C}$ , unless otherwise noted, integrated noise reported with 10-Hz to 100-kHz bandwidth.



### 6.7 Typical Characteristics (continued)

$V_{IN} = 2.5\text{ V}$ ,  $V_{OUT} = 1.8\text{ V}$ ,  $V_{BIAS} = 5\text{ V}$ ,  $I_{OUT} = 1\text{ A}$ ,  $C_{OUT} = 2 \times 100\text{ }\mu\text{F}$ ,  $C_{SS} = 4.7\text{ }\mu\text{F}$ ,  $R_{REF} = 12.0\text{ k}\Omega$ ,  $R_{BIAS} = 10\text{ }\Omega$ ,  $C_{BIAS} = 4.7\text{ }\mu\text{F}$ ,  $T_A = 25^\circ\text{C}$ , unless otherwise noted, integrated noise reported with 10-Hz to 100-kHz bandwidth.

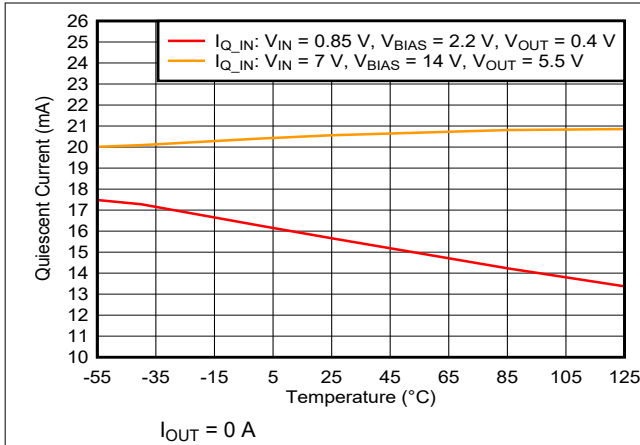


Figure 6-32. Quiescent Current vs Temperature

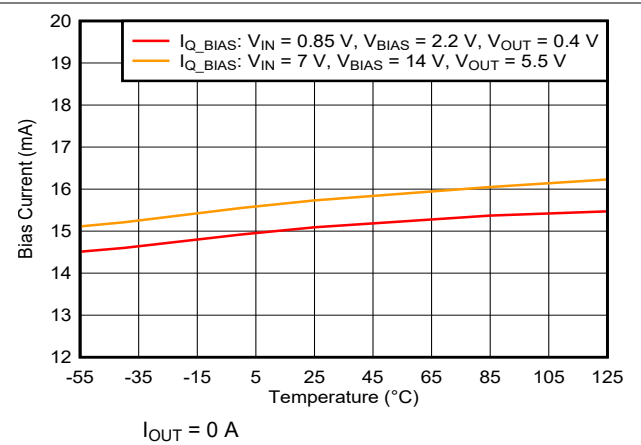


Figure 6-33. Bias Current vs Temperature

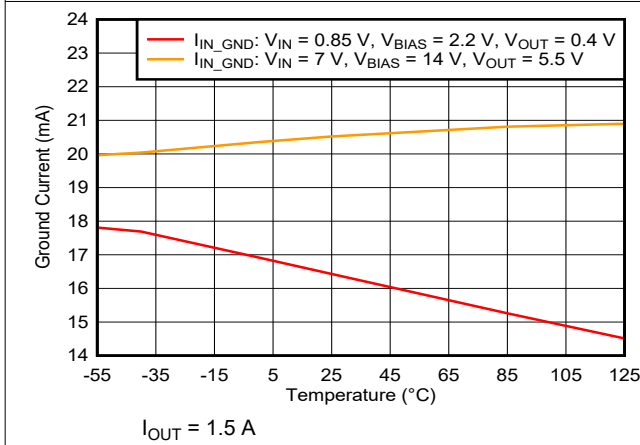


Figure 6-34. Ground Current vs Temperature

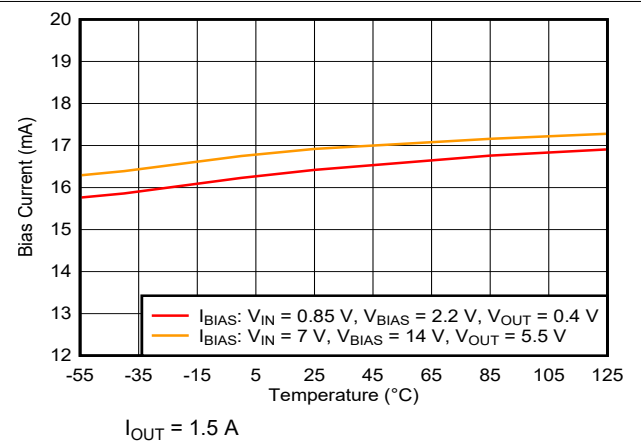


Figure 6-35. Bias Current vs Temperature

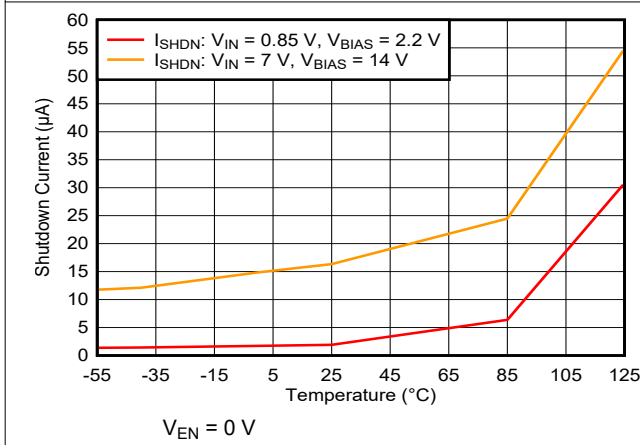


Figure 6-36. Shutdown Current vs Temperature

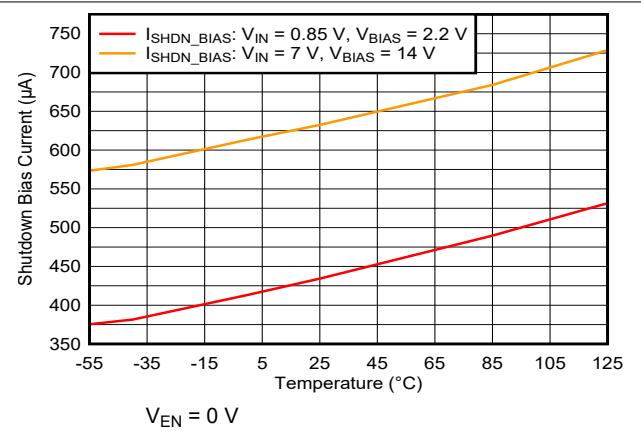
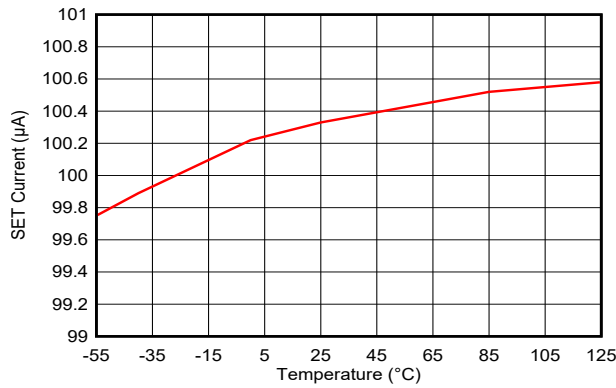


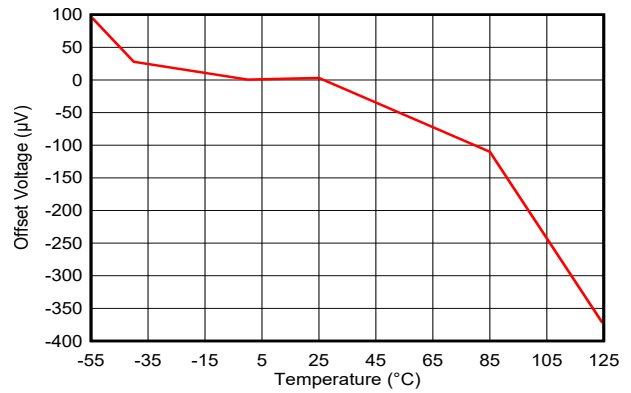
Figure 6-37. Bias Shutdown Current vs Temperature

### 6.7 Typical Characteristics (continued)

$V_{IN} = 2.5\text{ V}$ ,  $V_{OUT} = 1.8\text{ V}$ ,  $V_{BIAS} = 5\text{ V}$ ,  $I_{OUT} = 1\text{ A}$ ,  $C_{OUT} = 2 \times 100\text{ }\mu\text{F}$ ,  $C_{SS} = 4.7\text{ }\mu\text{F}$ ,  $R_{REF} = 12.0\text{ k}\Omega$ ,  $R_{BIAS} = 10\text{ }\Omega$ ,  $C_{BIAS} = 4.7\text{ }\mu\text{F}$ ,  $T_A = 25^\circ\text{C}$ , unless otherwise noted, integrated noise reported with 10-Hz to 100-kHz bandwidth.

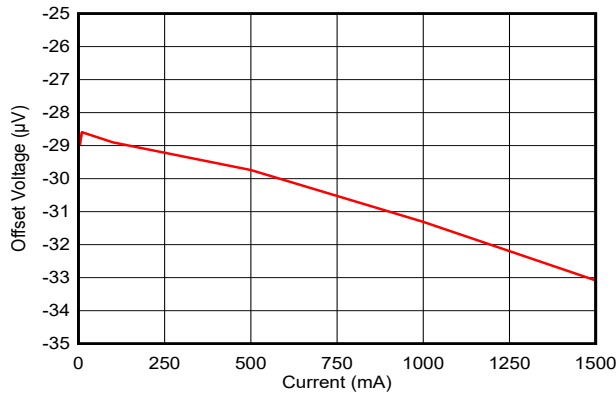


**Figure 6-38. SET Pin Current vs Temperature**

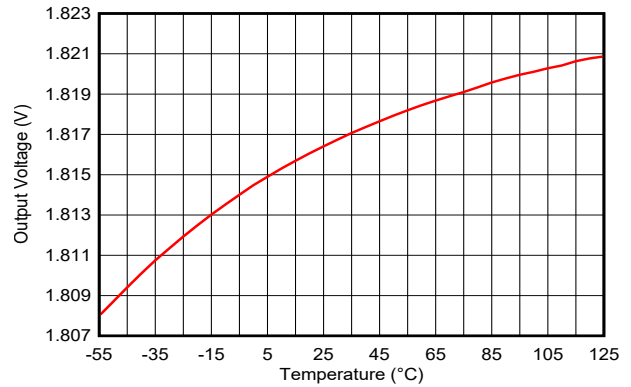


$I_{OUT} = 1\text{ mA}$

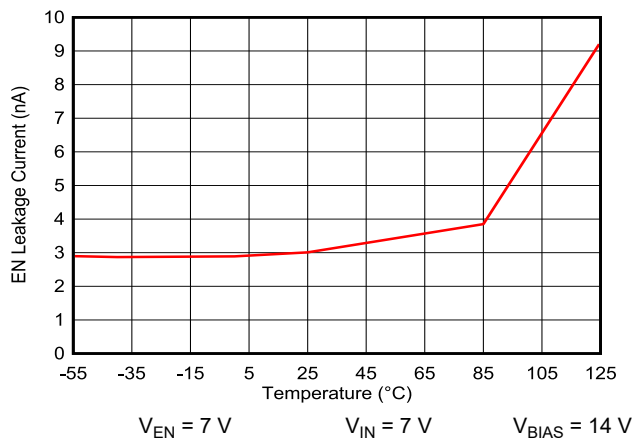
**Figure 6-39. Offset Voltage vs Temperature**



**Figure 6-40. Offset Voltage vs Current**

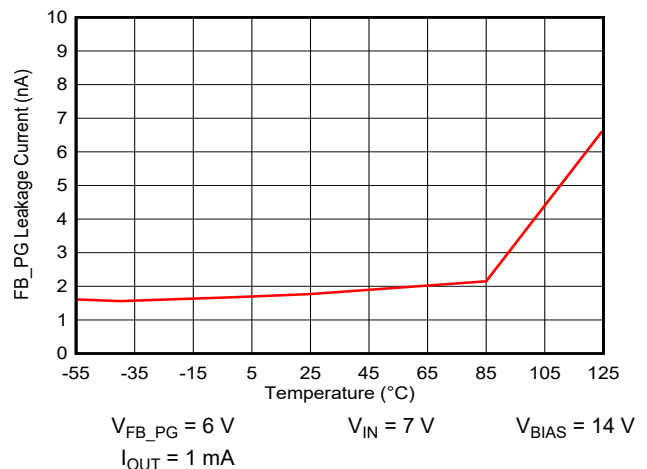


**Figure 6-41. Output Voltage vs Temperature**



$V_{EN} = 7\text{ V}$        $V_{IN} = 7\text{ V}$        $V_{BIAS} = 14\text{ V}$

**Figure 6-42. Enable Leakage Current vs Temperature**

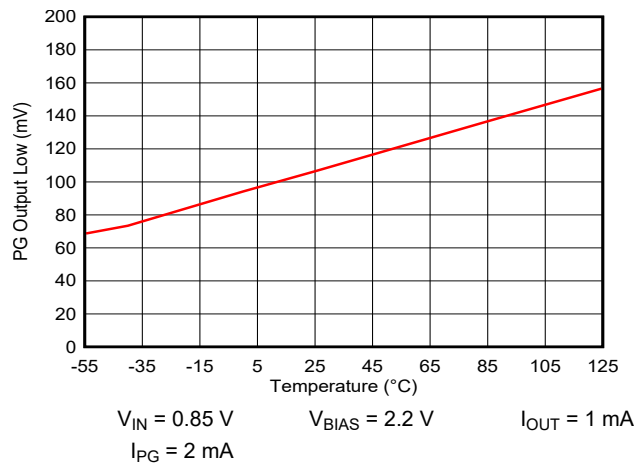
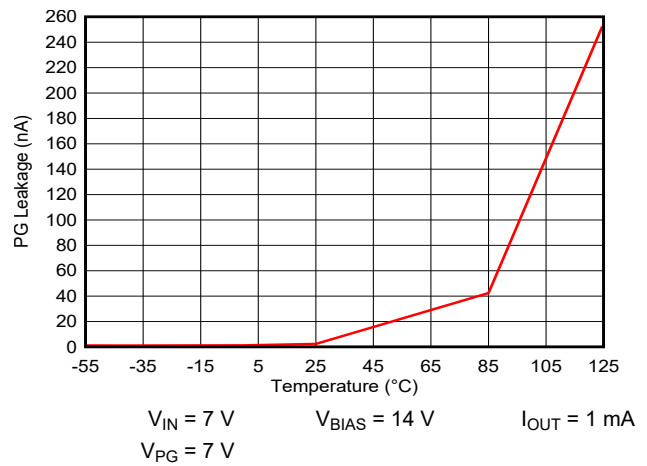
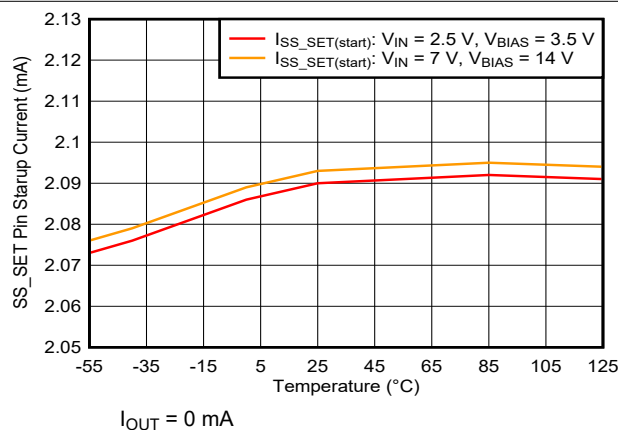
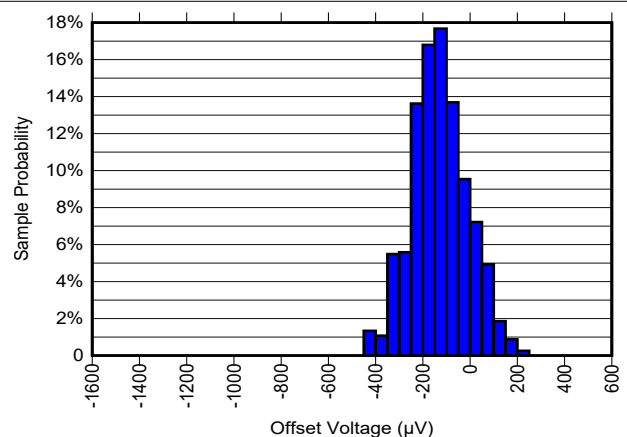
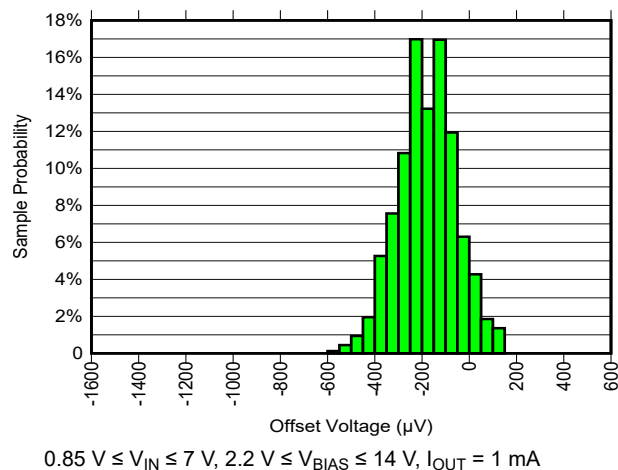
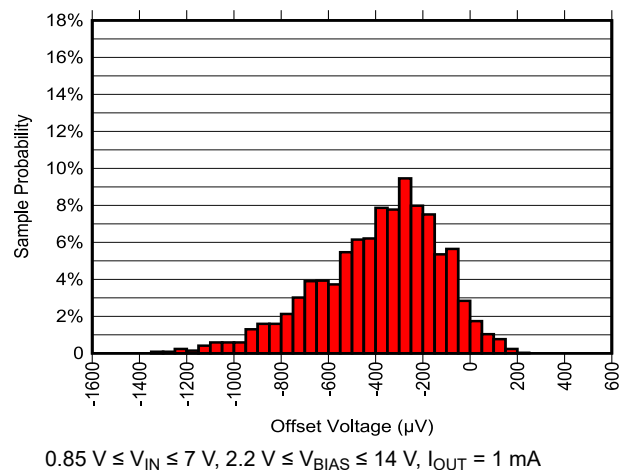


$V_{FB\_PG} = 6\text{ V}$        $V_{IN} = 7\text{ V}$        $V_{BIAS} = 14\text{ V}$   
 $I_{OUT} = 1\text{ mA}$

**Figure 6-43. FB\_PG Pin Leakage Current vs Temperature**

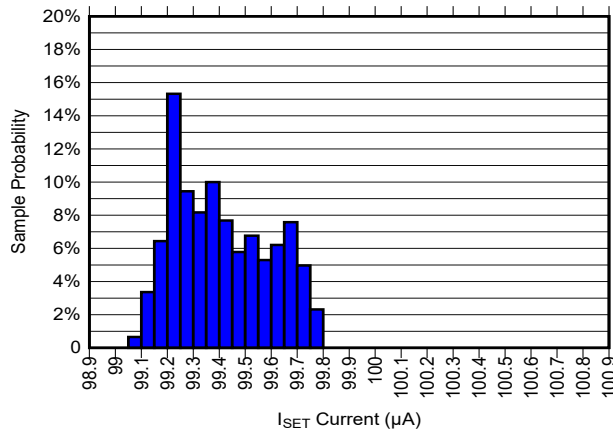
## 6.7 Typical Characteristics (continued)

$V_{IN} = 2.5\text{ V}$ ,  $V_{OUT} = 1.8\text{ V}$ ,  $V_{BIAS} = 5\text{ V}$ ,  $I_{OUT} = 1\text{ A}$ ,  $C_{OUT} = 2 \times 100\text{ }\mu\text{F}$ ,  $C_{SS} = 4.7\text{ }\mu\text{F}$ ,  $R_{REF} = 12.0\text{ k}\Omega$ ,  $R_{BIAS} = 10\text{ }\Omega$ ,  $C_{BIAS} = 4.7\text{ }\mu\text{F}$ ,  $T_A = 25^\circ\text{C}$ , unless otherwise noted, integrated noise reported with 10-Hz to 100-kHz bandwidth.


**Figure 6-44. PG Pin Output Low vs Temperature**

**Figure 6-45. PG Pin Leakage vs Temperature**

**Figure 6-46. SS\_SET Pin Current During Startup vs Temperature**

**Figure 6-47. Output Offset Voltage Distribution at  $T_A = -55^\circ\text{C}$** 

**Figure 6-48. Output Offset Voltage Distribution at  $T_A = 25^\circ\text{C}$** 

**Figure 6-49. Output Offset Voltage Distribution at  $T_A = 125^\circ\text{C}$**

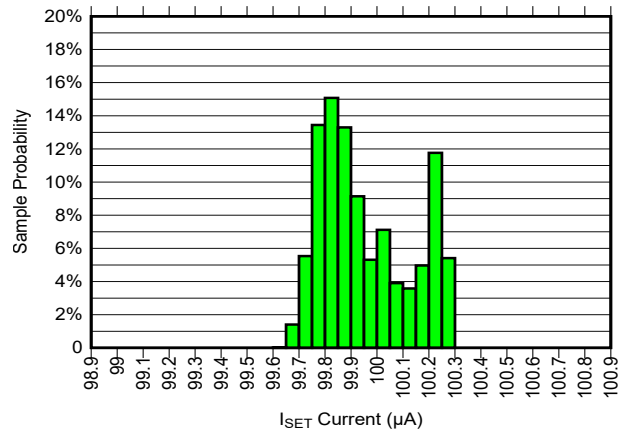
### 6.7 Typical Characteristics (continued)

$V_{IN} = 2.5\text{ V}$ ,  $V_{OUT} = 1.8\text{ V}$ ,  $V_{BIAS} = 5\text{ V}$ ,  $I_{OUT} = 1\text{ A}$ ,  $C_{OUT} = 2 \times 100\ \mu\text{F}$ ,  $C_{SS} = 4.7\ \mu\text{F}$ ,  $R_{REF} = 12.0\ \text{k}\Omega$ ,  $R_{BIAS} = 10\ \Omega$ ,  $C_{BIAS} = 4.7\ \mu\text{F}$ ,  $T_A = 25^\circ\text{C}$ , unless otherwise noted, integrated noise reported with 10-Hz to 100-kHz bandwidth.



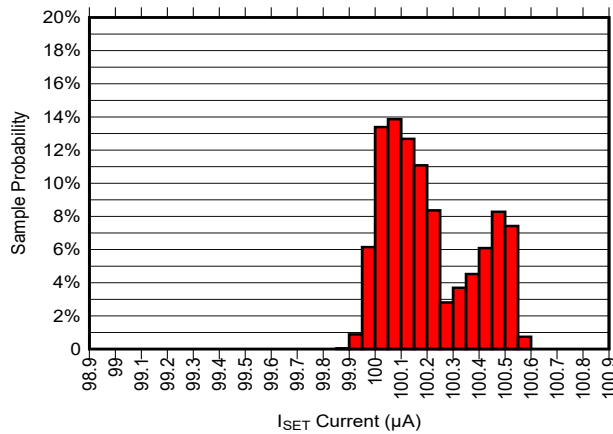
$0.85\text{ V} \leq V_{IN} \leq 7\text{ V}$ ,  $2.2\text{ V} \leq V_{BIAS} \leq 14\text{ V}$ ,  $I_{OUT} = 1\text{ mA}$

**Figure 6-50. I<sub>SET</sub> Current Distribution at T<sub>A</sub> = -55°C**



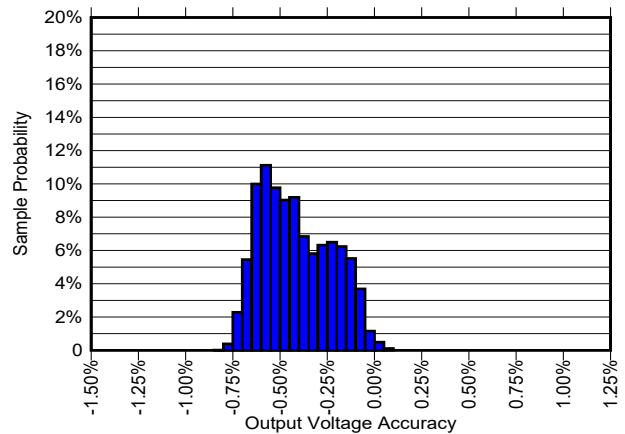
$0.85\text{ V} \leq V_{IN} \leq 7\text{ V}$ ,  $2.2\text{ V} \leq V_{BIAS} \leq 14\text{ V}$ ,  $I_{OUT} = 1\text{ mA}$

**Figure 6-51. I<sub>SET</sub> Current Distribution at T<sub>A</sub> = 25°C**



$0.85\text{ V} \leq V_{IN} \leq 7\text{ V}$ ,  $2.2\text{ V} \leq V_{BIAS} \leq 14\text{ V}$ ,  $I_{OUT} = 1\text{ mA}$

**Figure 6-52. I<sub>SET</sub> Current Distribution at T<sub>A</sub> = 125°C**

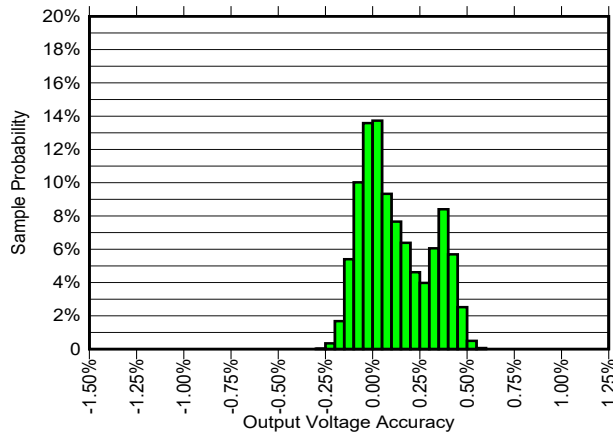


$0.85\text{ V} \leq V_{IN} \leq 7\text{ V}$ ,  $1\text{ mA} \leq I_{OUT} \leq 1.5\text{ A}$ ,  $2.2\text{ V} \leq V_{BIAS} \leq 14\text{ V}$ ,  $P_D \leq 4\text{ W}$

**Figure 6-53. Output Voltage Accuracy Distribution at T<sub>A</sub> = -55°C**

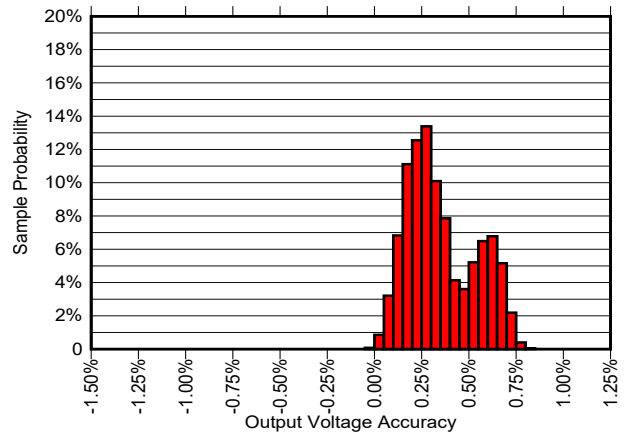
## 6.7 Typical Characteristics (continued)

$V_{IN} = 2.5\text{ V}$ ,  $V_{OUT} = 1.8\text{ V}$ ,  $V_{BIAS} = 5\text{ V}$ ,  $I_{OUT} = 1\text{ A}$ ,  $C_{OUT} = 2 \times 100\ \mu\text{F}$ ,  $C_{SS} = 4.7\ \mu\text{F}$ ,  $R_{REF} = 12.0\ \text{k}\Omega$ ,  $R_{BIAS} = 10\ \Omega$ ,  $C_{BIAS} = 4.7\ \mu\text{F}$ ,  $T_A = 25^\circ\text{C}$ , unless otherwise noted, integrated noise reported with 10-Hz to 100-kHz bandwidth.



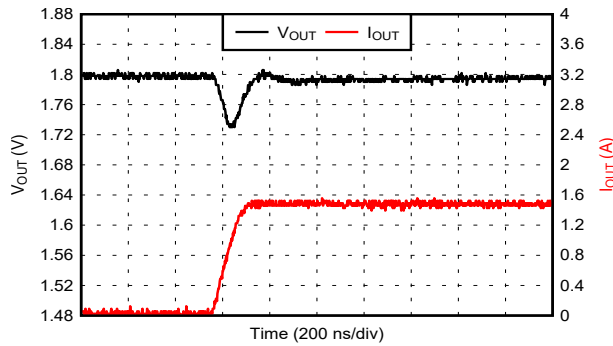
$0.85\text{ V} \leq V_{IN} \leq 7\text{ V}$ ,  $1\text{ mA} \leq I_{OUT} \leq 1.5\text{ A}$ ,  $2.2\text{ V} \leq V_{BIAS} \leq 14\text{ V}$ ,  
 $P_D \leq 4\text{ W}$

Figure 6-54. Output Voltage Accuracy Distribution at  $T_A = 25^\circ\text{C}$



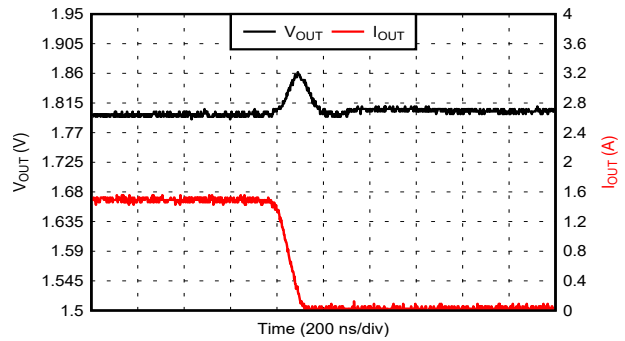
$0.85\text{ V} \leq V_{IN} \leq 7\text{ V}$ ,  $1\text{ mA} \leq I_{OUT} \leq 1.5\text{ A}$ ,  $2.2\text{ V} \leq V_{BIAS} \leq 14\text{ V}$ ,  
 $P_D \leq 4\text{ W}$

Figure 6-55. Output Voltage Accuracy Distribution at  $T_A = 125^\circ\text{C}$



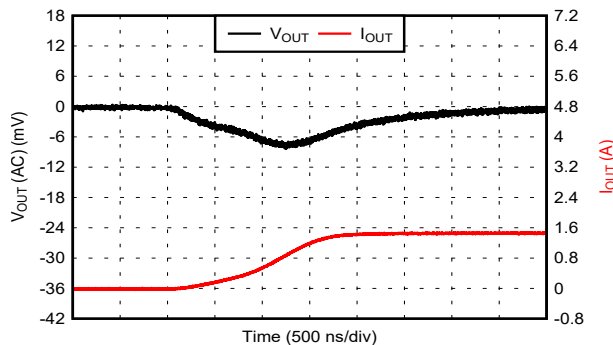
Slew Rate =  $10.1\text{ A}/\mu\text{s}$

Figure 6-56. Load Step: 1 mA to 1.5 A



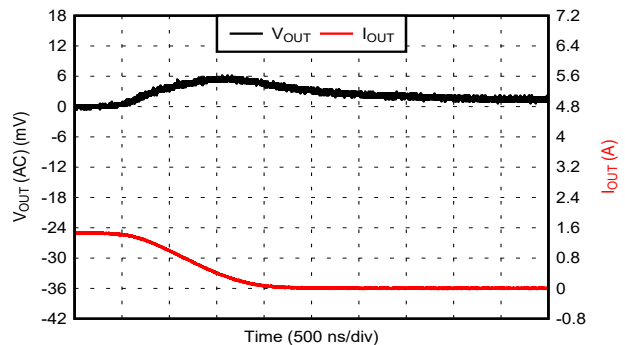
Slew Rate =  $13.1\text{ A}/\mu\text{s}$

Figure 6-57. Load Step: 1.5 A to 1 mA



Slew Rate =  $0.9\text{ A}/\mu\text{s}$

Figure 6-58. Load Step: 1 mA to 1.5 A

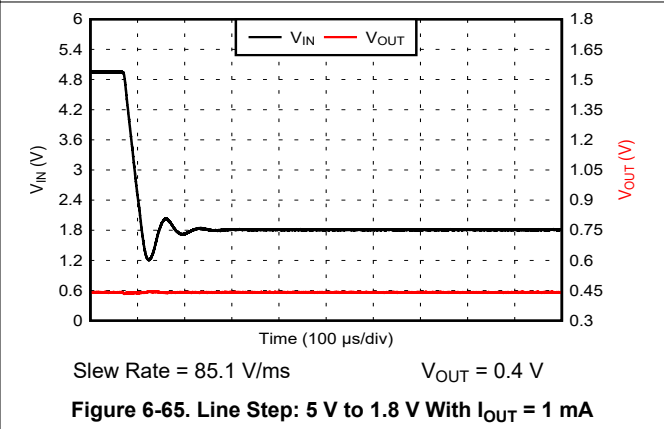
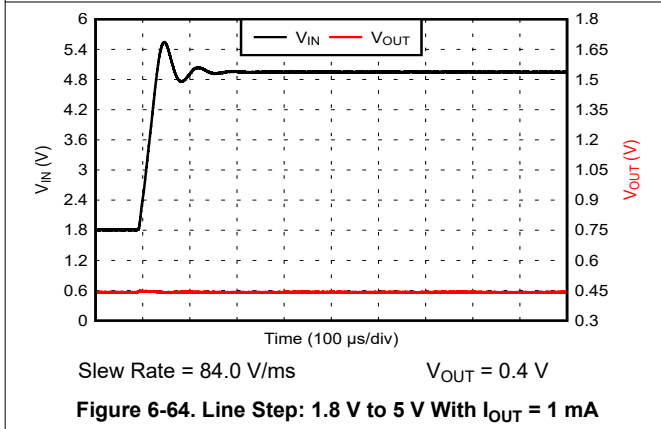
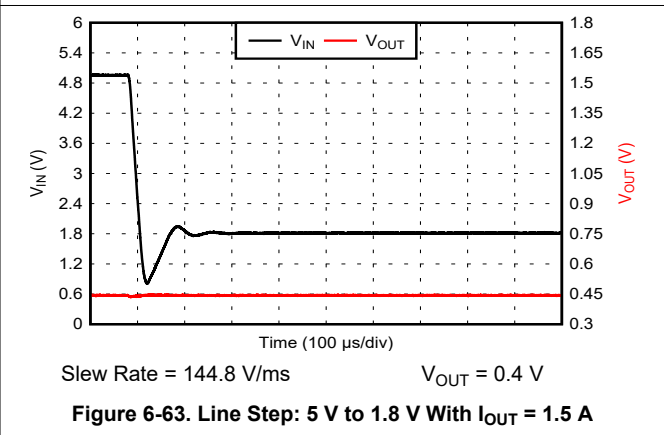
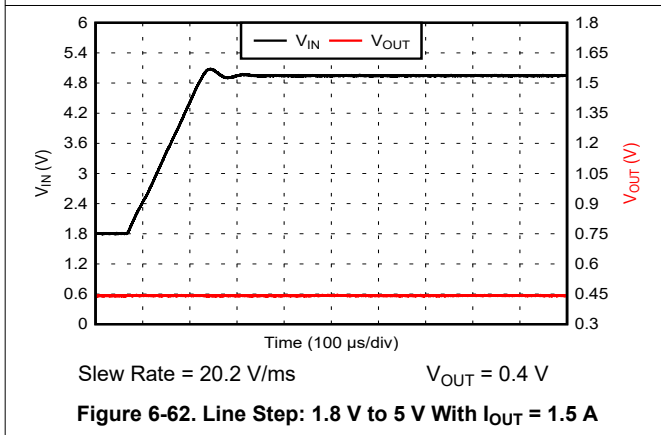
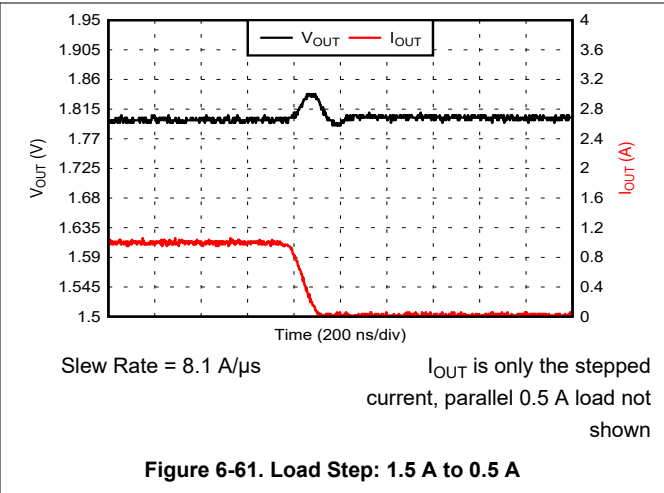
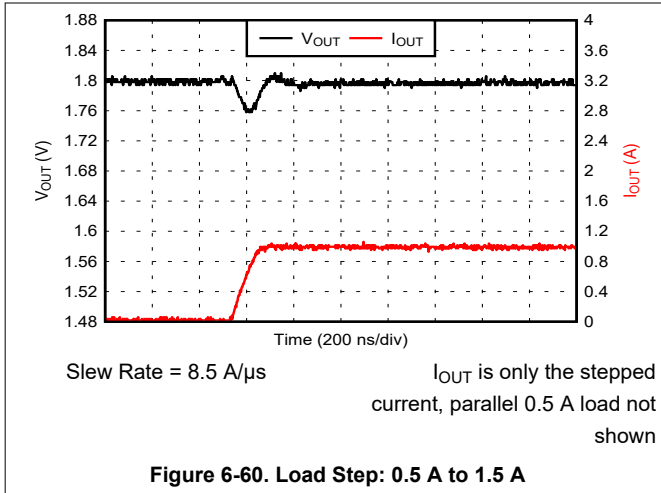


Slew Rate =  $1.0\text{ A}/\mu\text{s}$

Figure 6-59. Load Step: 1.5 A to 1 mA

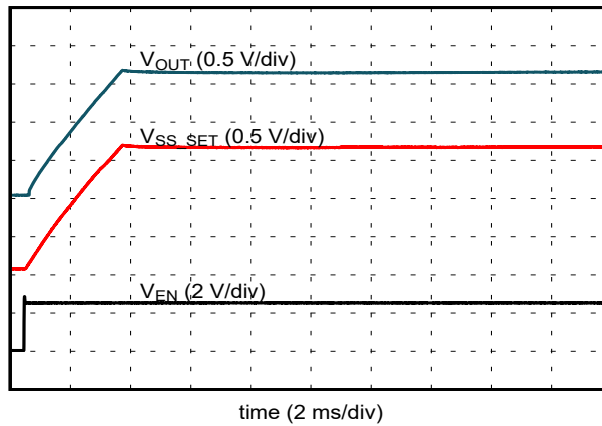
## 6.7 Typical Characteristics (continued)

$V_{IN} = 2.5\text{ V}$ ,  $V_{OUT} = 1.8\text{ V}$ ,  $V_{BIAS} = 5\text{ V}$ ,  $I_{OUT} = 1\text{ A}$ ,  $C_{OUT} = 2 \times 100\ \mu\text{F}$ ,  $C_{SS} = 4.7\ \mu\text{F}$ ,  $R_{REF} = 12.0\ \text{k}\Omega$ ,  $R_{BIAS} = 10\ \Omega$ ,  $C_{BIAS} = 4.7\ \mu\text{F}$ ,  $T_A = 25^\circ\text{C}$ , unless otherwise noted, integrated noise reported with 10-Hz to 100-kHz bandwidth.



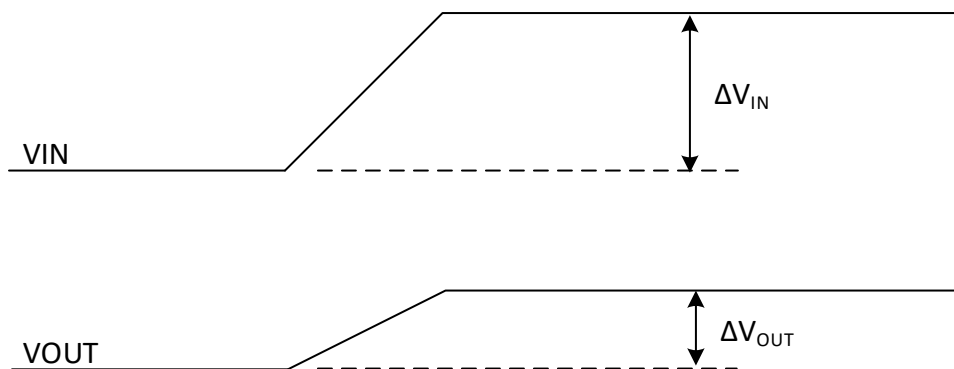
## 6.7 Typical Characteristics (continued)

$V_{IN} = 2.5\text{ V}$ ,  $V_{OUT} = 1.8\text{ V}$ ,  $V_{BIAS} = 5\text{ V}$ ,  $I_{OUT} = 1\text{ A}$ ,  $C_{OUT} = 2 \times 100\text{ }\mu\text{F}$ ,  $C_{SS} = 4.7\text{ }\mu\text{F}$ ,  $R_{REF} = 12.0\text{ k}\Omega$ ,  $R_{BIAS} = 10\text{ }\Omega$ ,  $C_{BIAS} = 4.7\text{ }\mu\text{F}$ ,  $T_A = 25^\circ\text{C}$ , unless otherwise noted, integrated noise reported with 10-Hz to 100-kHz bandwidth.



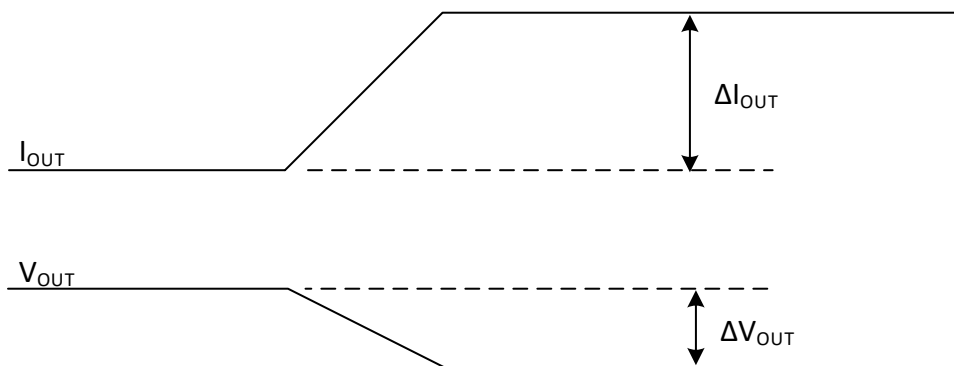
**Figure 6-66. Startup Waveform**

## 7 Parameter Measurement Information



- A.  $\Delta V_{OUT} / \Delta V_{IN} = 3 \mu\text{V/V}$  (typ). This means for a 1 V change in  $V_{IN}$  ( $\Delta V_{IN} = 1 \text{ V}$ ), there will be a 3  $\mu\text{V}$  change in  $V_{OUT}$  ( $\Delta V_{OUT} = 3 \mu\text{V}$ ). Line regulation is a DC parameter; therefore this waveform should only be considered valid after transients die out or for a slow  $V_{IN}$  slew rate.

**Figure 7-1. Line Regulation**



- A.  $\Delta V_{OUT} / \Delta I_{OUT} = 500 \mu\text{V/A}$  (typ). This means for a 1 A change in  $I_{OUT}$  ( $\Delta I_{OUT} = 1 \text{ A}$ ), there will be a 500  $\mu\text{V}$  change in  $V_{OUT}$  ( $\Delta V_{OUT} = 500 \mu\text{V}$ ). Load regulation is a DC parameter; therefore this waveform should only be considered valid after transients die out or for a slow  $I_{OUT}$  slew rate.

**Figure 7-2. Load Regulation**

## 8 Detailed Description

### 8.1 Overview

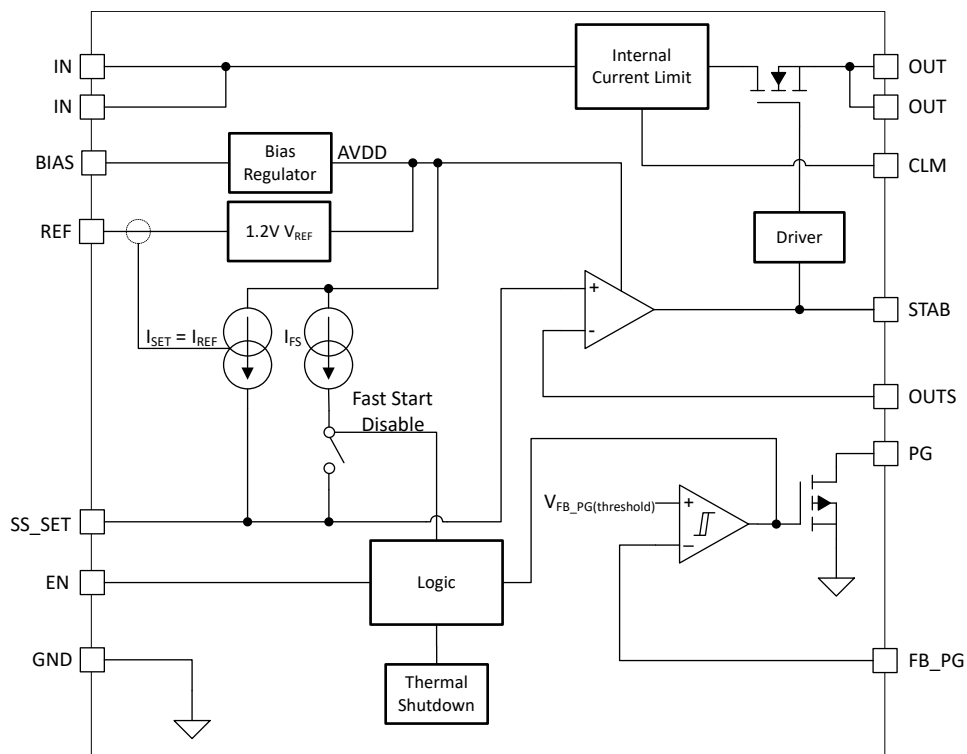
The TPS7H1111 (TPS7H1111-SP and TPS7H1111-SEP) is an ultra-low noise, high PSRR, low dropout linear regulator (LDO) optimized for powering RF devices in space. It uses an NMOS pass element and is capable of sourcing up to 1.5 A over a 0.85-V to 7-V input range. A BIAS pin (2.2 V to 14 V) enables the use of a bias rail to facilitate low  $V_{IN}$  to  $V_{OUT}$  operation, thus limiting power dissipation. The device creates an ultra-clean output rail and can be configured with minimal external components.

The radiation performance, combined with low-noise and high-PSRR operation, makes the TPS7H1111 ideal for powering noise-sensitive components in satellites. The high performance of the device limits power-supply generated phase noise and clock jitter, making this device ideal for powering high-performance ADCs, DACs, VCOs, PLLs, SerDes, and other RF components.

For digital loads, such as ASICs (application specific integrated circuits), FPGAs, and DSPs, requiring low-input voltage and low-output voltage operation, the exceptional accuracy (+1.2% / -1.3% over line, load, and temperature), remote sensing, excellent transient performance, and soft-start capabilities of the TPS7H1111 ensure optimal system performance.

Additionally, various features are incorporated into the regulator to simplify the electrical system and provide system flexibility. These features include enable functionality (EN), configurable power good output (PG), soft-start control (SS\_SET), an internal current limit with configurable behavior (CLM), and external loop compensation (STAB).

### 8.2 Functional Block Diagram



## 8.3 Feature Description

### 8.3.1 Bias Supply

A bias supply connected to the BIAS pin is required for proper device operation. Depending on the headroom voltage and output current conditions, the bias supply voltage may be the same as the input voltage supply, or it may be a separate higher voltage supply. Note that headroom voltage is defined as the delta between the operating  $V_{IN}$  and  $V_{OUT}$  conditions ( $V_{headroom} = V_{IN} - V_{OUT}$ ). In all cases, there are no sequencing requirements between  $V_{BIAS}$  and  $V_{IN}$ .

As described in [Table 8-1](#), if the headroom voltage is greater than or equal to 1.6 V, no separate higher bias supply is required. If the headroom voltage is less than 1.6 V, a separate higher bias supply voltage is required for full performance. In all situations shown in [Table 8-1](#) it is possible to achieve the full 1.5 A of output current with the specified dropout voltage (see the [Electrical Characteristics](#) table).

**Table 8-1. Bias Rail Requirements for Full Performance Operation**

Headroom ( $V_{IN} - V_{OUT}$ )	Bias Requirement <sup>(1)</sup>
$\geq 1.6$ V	Use the same voltage rail as $V_{IN}$ or any $V_{BIAS} \geq V_{IN}$
$< 1.6$ V	Use a separate voltage rail than $V_{IN}$ where $V_{BIAS} \geq V_{OUT} + 1.6$ V

(1) In all cases  $2.2$  V  $\leq V_{BIAS} \leq 14$  V

[Table 8-2](#) shows examples of supported  $V_{BIAS}$ ,  $V_{IN}$ , and  $V_{OUT}$  combinations that can be achieved with standard voltage rails and result in full 1.5 A output current support. As can be seen, a 12 V bias supply will support all listed standard output voltage rails (generally a 5 V supply will also suffice). Also note that for the conditions where the  $V_{BIAS}$  and  $V_{IN}$  voltages are the same, a separate supply is not required.

**Table 8-2. Bias Rail Standard Rail Examples for Full Performance Operation**

$V_{BIAS}$ (V)	$V_{IN}$ (V)	$V_{OUT}$ (V)
12	5	3.3
	5, 3.3	2.5
	5, 3.3, 2.5	1.8
	5, 3.3, 2.5, 1.8	1.1
5	5, 3.3	2.5
	5, 3.3, 2.5	1.8
	5, 3.3, 2.5, 1.8	1.1
3.3	3.3, 2.5, 1.8	1.1

While it is generally recommended to follow the above bias voltage requirements, sometimes it is not feasible (for example, if the headroom is small and a separate bias voltage rail is not available). In this case, it is still possible to operate the TPS7H1111 at the expense of reduced output current (and possibly reduced performance such as PSRR). This condition (where  $V_{BIAS} = V_{IN}$  and headroom is small) is specified as *Dropout voltage with  $V_{BIAS} = V_{IN}$*  in the [Electrical Characteristics](#) table. By meeting the resulting dropout voltage requirements, the part maintains proper operation.

An example of a supported combination that may not result in full performance capabilities is with  $V_{BIAS} = V_{IN} = 5$  V and  $V_{OUT} = 3.3$  V. Assuming the 5 V rail has a 5% tolerance and the 3.3 V output has a specified maximum tolerance of +1.2% tolerance, the worst case headroom is  $V_{headroom} = 4.75 - 3.34 = 1.41$  V. This 1.41 V is less than the 1.6 V recommended. However, as shown in the [Electrical Characteristics](#) table, this headroom is greater than the dropout required at the full load current of 1.5 A. Therefore, it is expected that the full current will be supported, but other parameters may not be at full performance (such as PSRR).

Any noise on the bias rail will be attenuated by the  $PSRR_{BIAS}$  specification before being coupled to the output. Unless the bias rail is an ultra-clean rail, this noise coupling would be the limiting factor in creating a clean output voltage. Therefore, an RC filter should be used to minimize noise input to the BIAS pin. This is feasible

due to the low current requirements of the BIAS pin. A 10  $\Omega$  and 4.7  $\mu\text{F}$  is generally sufficient to ensure the noise propagated from the BIAS pin to the output voltage is minimized. The selected resistor value must be low enough to ensure the resulting IR drop doesn't cause the bias voltage to become too low for proper operation.

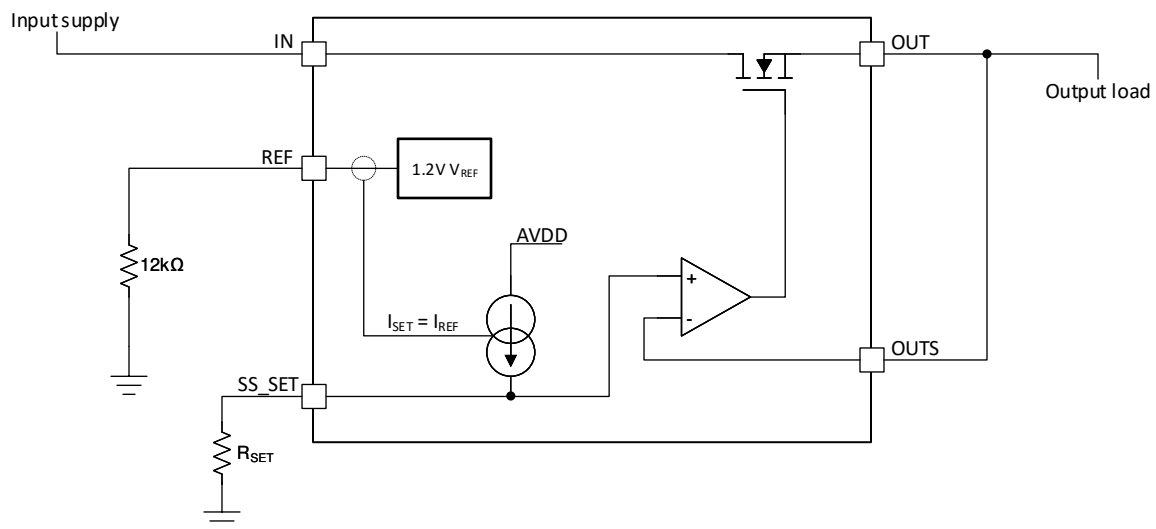
### 8.3.2 Output Voltage Configuration

The output voltage of the TPS7H1111 is set by placing a resistor,  $R_{\text{SET}}$ , from the SS\_SET pin to GND. During nominal operation, 100  $\mu\text{A}$  is output from the SS\_SET pin. By appropriately selecting  $R_{\text{SET}}$ , the desired output voltage will be generated on the SS\_SET pin as calculated in Equation 1. This voltage will be replicated on the output through the internal unity gain error amplifier as shown in Figure 8-1.

$$V_{\text{SS\_SET}} = I_{\text{SET}} \times R_{\text{SET}} \quad (1)$$

where

- $I_{\text{SET}} = 100 \mu\text{A}$  (typ)
- $V_{\text{SS\_SET}}$  = set voltage that is configured to the desired output voltage,  $V_{\text{OUT}}$



**Figure 8-1. Simplified Schematic to Configure Output Voltage**

The 100  $\mu\text{A}$  reference current is configured by placing a 12 k $\Omega$  resistor from the REF pin to GND. The 1.2 V across the  $R_{\text{REF}}$  resistor will create an approximate 100  $\mu\text{A}$  reference current. This current is mirrored to the SS\_SET pin to create a highly accurate reference current. Generally 0.1% precision resistors are recommended for  $R_{\text{REF}}$  and  $R_{\text{SET}}$  to precisely set the currents. If precision 0.1% resistors are utilized, the  $I_{\text{SS\_SET}}$  error due to the  $R_{\text{REF}}$  resistor will be 0.1%. Additionally, the 0.1% error of the  $R_{\text{SET}}$  resistor will also contribute to  $V_{\text{OUT}}$  accuracy error. The TPS7H1111 accuracy specification is +1.2% / -1.3% across line, load, and temperature, but resistor tolerance error must be separately added. Common output voltages and resistor values are shown in Table 8-3.

**Table 8-3. R<sub>SET</sub> Values for Indicated V<sub>OUT</sub>**

Output Voltage, V <sub>OUT</sub>	Value for 0.1% Tolerance Resistors
0.4 V	4.02 kΩ
0.7 V	6.98 kΩ
1 V	10 kΩ
1.1 V	11 kΩ
1.2 V	12 kΩ
1.5 V	15 kΩ
1.8 V	18 kΩ
2.5 V	24.9 kΩ
3.3 V	33.2 kΩ
4 V	40.2 kΩ
5 V	49.9 kΩ

Additionally, if greater accuracy is desired, matched resistors may be utilized (which are often available in accuracy ratios better than 0.1%). For example, a nominal 12 kΩ ± 5% resistor could be selected for R<sub>REF</sub> with a matched resistor so that the that R<sub>SET</sub> / R<sub>REF</sub> ratio is 0.01% (or even better). In this case, instead of Equation 1 to calculate the set voltage, use Equation 2.

$$V_{SS\_SET} = (1.2 / R_{REF}) \times R_{SET} \quad (2)$$

where

- V<sub>SS\_SET</sub> = set voltage that is set to the desired output voltage, V<sub>OUT</sub>

Equation 2 allows one to easily calculate errors in the set output voltage due to R<sub>REF</sub> and R<sub>SET</sub> resistor mismatch. However, while improved resistor ratios will likely improve the output accuracy, other error sources are still present. These sources include the inherent reference current accuracy itself and error amplifier offset voltage.

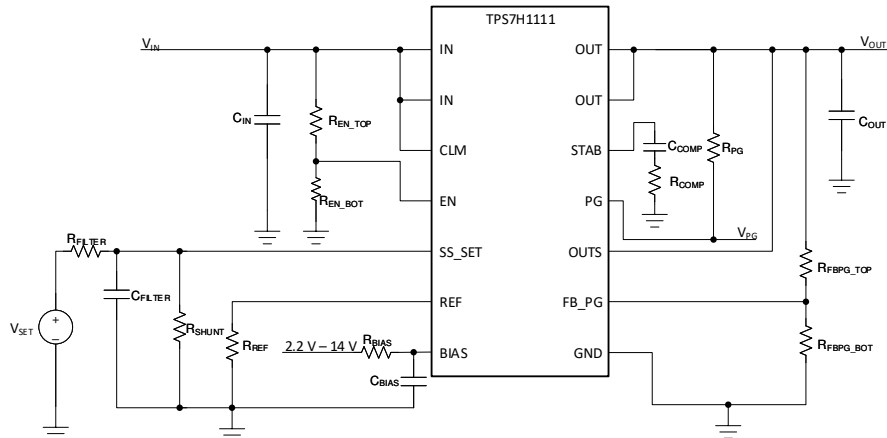
The output voltage accuracy, V<sub>ACC</sub>, specifies a minimum accuracy of –1.3% and maximum accuracy of +1.2% in the Electrical Characteristics table. This specification applies across the complete temperature range of –55°C to 125°C, across all the input voltages (0.85 V ≤ V<sub>IN</sub> ≤ 7 V and 2.2 V ≤ V<sub>BIAS</sub> ≤ 14 V), and up to full load (1 mA ≤ I<sub>OUT</sub> ≤ 1.5 A). A few additional details to the measurement are noted:

- The range of V<sub>IN</sub>, V<sub>BIAS</sub>, I<sub>OUT</sub>, and temperature mean the specification applies across all line, load, and temperature combinations. This is accomplished by testing multiple bias conditions that cover various corners.
- Footnote 4 in the Electrical Characteristics specifies V<sub>BIAS</sub> ≥ V<sub>IN</sub> and V<sub>BIAS</sub> ≥ V<sub>OUT</sub> + 1.6 V. This is because not all extreme corners of V<sub>IN</sub> and V<sub>BIAS</sub> are feasible (for example, V<sub>IN</sub> = 7 V and V<sub>BIAS</sub> = 2.2 V would not make sense).
- Footnote 5 in the Electrical Characteristics specifies that the measurement is done with a power dissipation that is limited to a maximum of 4 W. This is due to tester thermal limitations. On a typical application board with good thermals, there is no inherent limitation.
- The test conditions specify a minimum of 1 mA and not 0 mA for more robust accuracy measurements. However, in a normal application the TPS7H1111 device does not have a minimum load current for stability.
- The post TID specification is measured at room temperature (a MIL standard in order to avoid annealing at high temperatures). The TPS7H1111 is specified post TID to have a minimum accuracy of –0.7% and maximum of +1.1%. This is compared to a pre-TID accuracy of –0.7% and maximum of +0.9%.
- TI does not recommend including the following error terms into the V<sub>ACC</sub> specification as they are inherently covered in the V<sub>ACC</sub> parameter itself: I<sub>SET</sub> current accuracy, V<sub>OS</sub> (output offset voltage), V<sub>REF</sub> voltage accuracy, ΔV<sub>OUT</sub>/ΔV<sub>IN</sub> (line regulation), ΔV<sub>OUT</sub>/ΔI<sub>OUT</sub> (load regulation), or V<sub>OUT</sub>tempco.
- The error due to external components, such as R<sub>REF</sub> and R<sub>SET</sub> resistor tolerances, may be added to V<sub>ACC</sub> specifications as this is not included in the parameter.

For additional information on determining output voltage accuracy, see [Section 9.2.1.2.3](#).

### 8.3.3 Output Voltage Configuration with a Voltage Source

Since the TPS7H1111 output voltage is equal to the SS\_SET voltage (minus any offset error), it is also possible to configure the TPS7H1111 by providing a voltage on SS\_SET. As shown in [Figure 8-2](#), a voltage source,  $V_{SET}$ , is fed to SS\_SET. A DAC can be used as the voltage source to enable a configurable voltage control.



**Figure 8-2. Simplified Schematic to Configure Output Voltage with a Voltage Source on SS\_SET**

A few unique considerations should be taken into account when using this method:

- When a voltage source is provided on SS\_SET, instead of relying on the ultra-low noise reference current, the noise of  $V_{SET}$  is passed to the output through the unity gain error amplifier. It may be advisable to use an RC filter between  $V_{SET}$  and SS\_SET as shown to minimize noise.
- Since the TPS7H1111 output voltage directly follows SS\_SET, there will be no soft-start during startup. It is recommended to control the  $V_{SET}$  voltage slew rate to ensure desired soft-start time. An RC filter between  $V_{SET}$  and the SS\_SET may help with this slew rate control.
- The SS\_SET pin will output a nominal 100  $\mu$ A during operation and 2.1 mA during "soft-start" (when  $V_{FB\_PG} < V_{FB\_PG(rising)}$ ). In order to handle this current, a shunt resistor may be required.

### 8.3.4 Enable

When the enable pin is low, the device will enter shutdown mode and not regulate the output voltage. Normally, an external resistor divider from  $V_{IN}$  to GND is used to feed EN. The resistors can be appropriately sized in order to turn on the device when a desired preset input voltage is reached as shown in [Equation 3](#).

$$V_{IN(rising)} = V_{EN(rising)} \times (R_{EN\_TOP} + R_{EN\_BOT}) / R_{EN\_BOT} \quad (3)$$

Similarly, a  $V_{IN(falling)}$  voltage can also be calculated using [Equation 4](#). The  $V_{IN(rising)}$  and  $V_{IN(falling)}$  can be thought of as configurable UVLO (undervoltage-lockout) thresholds.

$$V_{IN(falling)} = V_{EN(falling)} \times (R_{EN\_TOP} + R_{EN\_BOT}) / R_{EN\_BOT} \quad (4)$$

While the TPS7H1111 will turn-on at a  $V_{EN}$  of 0.6 V (typ), it is recommended that the final value of  $V_{EN}$  is above 0.8 V. This is to ensure appropriate margin above the enable threshold during normal operation to prevent SEFIs during exposure to heavy ions. This recommendation is achieved by satisfying [Equation 5](#).

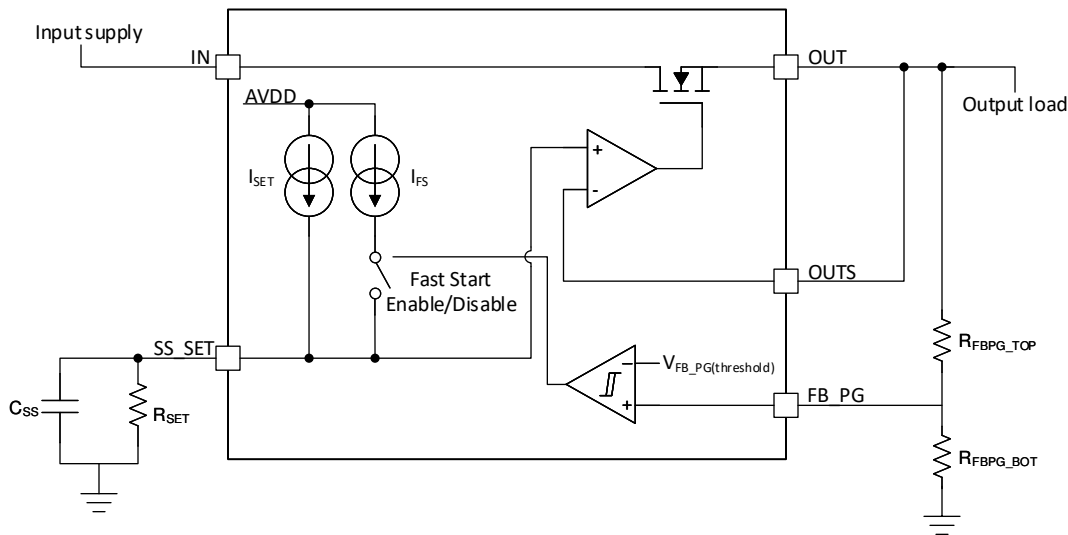
$$V_{IN(final)} \times R_{EN\_BOT} / (R_{EN\_TOP} + R_{EN\_BOT}) = V_{EN(final)} > 0.8 \text{ V} \quad (5)$$

Alternatively, the EN pin may be driven directly from a microcontroller or FPGA. The low voltage threshold of the enable pin aids in support of 1.1-, 1.8-, 2.5-, and 3.3 V logic levels. Similarly it is recommended the final value of  $V_{EN}$  is above 0.8 V (this is typically easily achieved with standard logic levels).

### 8.3.5 Soft Start and Noise Reduction

In addition to setting the output voltage, the SS\_SET pin serves two other important functions: programming the soft start time and creating a noise filter for the internal reference current. In most applications, at least a 4.7  $\mu\text{F}$  capacitor is recommended in order to obtain sufficient low noise performance. Larger value capacitors may be acceptable; however, there are diminishing returns in reduced output noise in capacitor values larger than 4.7  $\mu\text{F}$ .

This capacitor also slows down the SS\_SET voltage ramp rate, and therefore controls the LDO turn-on time (soft start). However, if the capacitor was only charged by the  $I_{\text{SET}}$  current (nominally 100  $\mu\text{A}$ ), the startup time would be excessive. Therefore, there is an additional fast charge current source ( $I_{\text{FS}} \approx 2 \text{ mA}$ ) that is active during startup. Consequently, a 4.7  $\mu\text{F}$  capacitor will result in a nominal 3.7 ms soft start time. A simplified diagram of this circuitry is shown in Figure 8-3.



**Figure 8-3. Simplified Schematic Showing Startup Circuitry**

This fast charge circuitry is active until the FB\_PG threshold is reached (typically 300 mV). After the FB\_PG threshold has been reached, the fast start current will turn off and the soft start time as shown in Equation 6 will be completed.  $C_{\text{SS}}$  will continue charging to its final value (as determined by the  $R_{\text{SET}}$  resistor) with the 100  $\mu\text{A}$  (typ) reference current. An example startup waveform is shown in Figure 8-4. In this waveform it is assumed EN is fed a divided down version of  $V_{\text{IN}}$ .

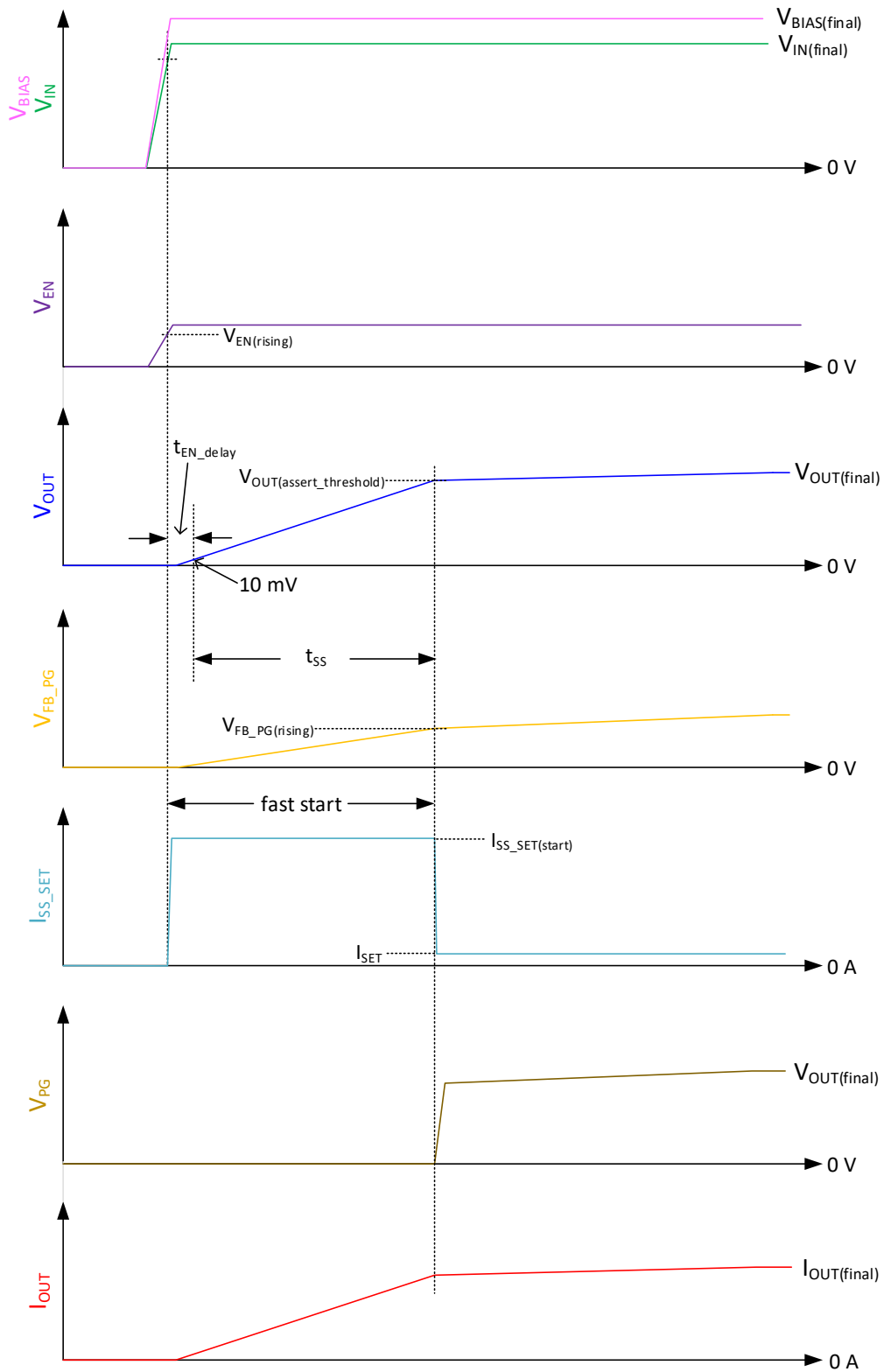
$$t_{\text{SS}} \approx C_{\text{SS}} \times V_{\text{OUT(assert\_threshold)}} / I_{\text{SS\_SET(startup)}} \quad (6)$$

where

- $t_{\text{SS}}$  = soft start time
- $I_{\text{SS\_SET(startup)}} = I_{\text{FS}} + I_{\text{SET}} = 2.1 \text{ mA (typ)}$
- $V_{\text{(assert\_threshold)}}$  = configured value of  $V_{\text{OUT}}$  for which PG is asserted (typically 90% of  $V_{\text{OUT(final)}}$ ), see Section 8.3.6

Note that the fast charge current ( $I_{\text{FS}}$ ) and set current ( $I_{\text{SET}}$ ) are both active during the soft start time ( $t_{\text{SS}}$ ) and are reported as  $I_{\text{SS\_SET(startup)}}$  in the Electrical Characteristics table. This 2.1 mA typical value is valid for a 12 k $\Omega$   $R_{\text{REF}}$  resistor. As the fast charge current is internally derived from the current through the  $R_{\text{REF}}$  resistor, values greater than or less than 12 k $\Omega$  will cause a decrease or increase of the  $I_{\text{FS}}$  current respectively.

If the fast start circuitry is not desired, connect the FB\_PG pin to  $V_{\text{OUT}}$ . This will ensure the fast start circuitry is quickly turned-off as the FB\_PG threshold is quickly reached. Note that this effects the PG pin behavior as well as described in Section 8.3.6.



**Figure 8-4. Simplified Schematic Showing Startup Waveforms**

### 8.3.6 Configurable Power Good

The power good indicator pin, PG, is an open drain pin that is asserted when the output voltage reaches the desired value. The PG pin may either be pulled-up through a resistor to  $V_{OUT}$ ,  $V_{IN}$ , or another voltage level less than the recommended maximum of 7 V. Select the resistor size to keep the maximum current sunk by PG to under the recommended operating condition current maximum of 2 mA.

Note that if PG is pulled-up to an external voltage before either  $V_{IN}$  or  $V_{BIAS}$  are supplied to the device, PG may not be pulled-down due to insufficient drive strength.  $V_{IN(MIN\_PG)}$  is specified in the [Electrical Characteristics](#) table as the minimum value either  $V_{IN}$  or  $V_{BIAS}$  must reach for PG to have sufficient pull-down strength to pull-down PG to under 0.5 V at less than or equal to 0.6 mA. Once  $V_{IN}$  and  $V_{BIAS}$  reach their proper final voltages, the PG pin has full drive strength.

By feeding the output voltage through a resistor divider to the FB\_PG pin, the PG assertion level can be configured. The FB\_PG pin has a typical threshold of 300 mV. When this threshold is reached or exceeded, the PG pin is asserted. [Equation 7](#) shows how to calculate the  $V_{OUT}$  value where PG is asserted (it does not take into account the FB\_PG pin leakage current which has minimal effect). As described in [Section 8.3.5](#) the fast start circuitry will also turn-off when this level is reached.

$$V_{FB\_PG(rising)} = V_{OUT(assert\_threshold)} \times R_{FBPG\_BOT} / (R_{FBPG\_TOP} + R_{FBPG\_BOT}) \quad (7)$$

To ensure PG is asserted by the time the final output voltage is reached, the worst case tolerances of output voltage, FB\_PG threshold, and resistor tolerance levels must be taken into account. Generally, configuring the resistor divider so  $V_{(assert\_threshold)}$  is 90% or less than  $V_{OUT(final)}$  is sufficient.

The PG deassert threshold can also be calculated using [Equation 8](#).

$$V_{FB\_PG(rising)} - V_{FB\_PG(hysteresis)} = V_{OUT(deassert\_threshold)} \times R_{FBPG\_BOT} / (R_{FBPG\_TOP} + R_{FBPG\_BOT}) \quad (8)$$

If the PG pin is not used, it may be pulled to ground. However, the FB\_PG pin must still be properly configured if the fast start circuitry described in [Section 8.3.5](#) is desired.

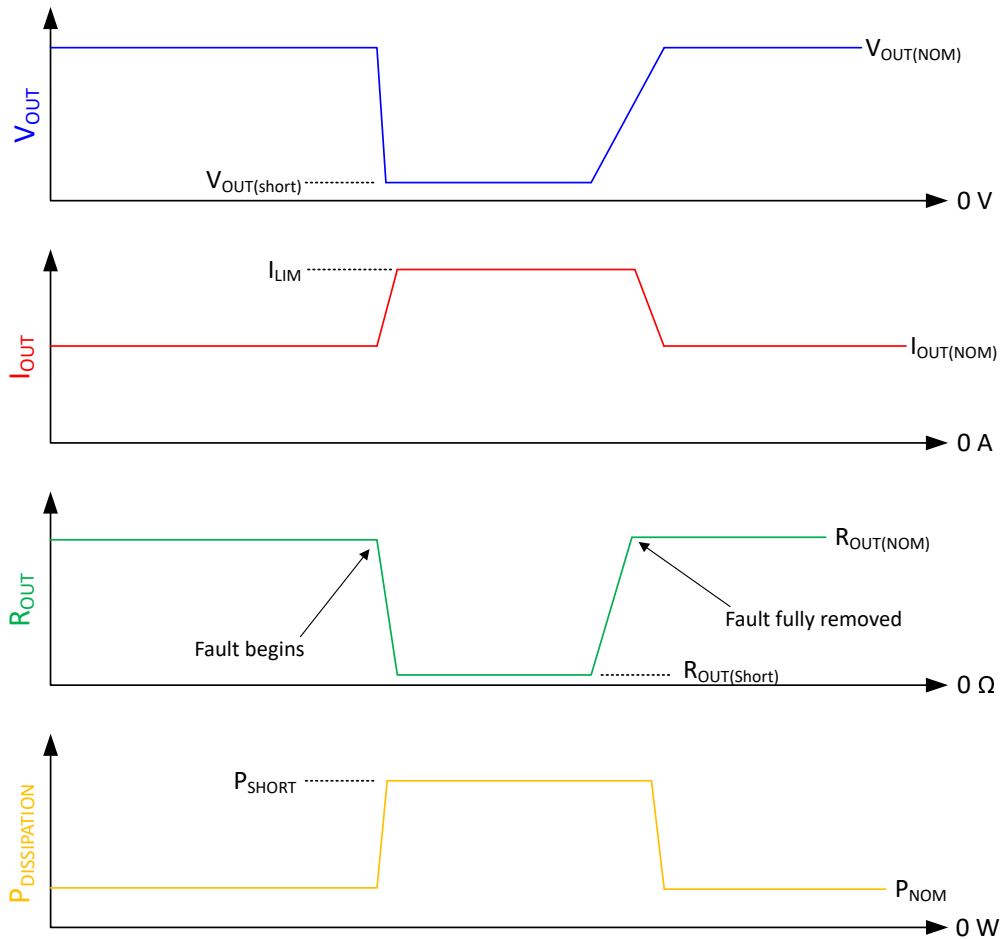
### 8.3.7 Current Limit

The internal current limit,  $I_{LIM}$ , is the current limit value. There are two types of current limit behavior, depending on the value of the CLM pin. First, when CLM is high, there is brick-wall current limit. When CLM is low, there is turn-off current limit. CLM may be connected directly to  $V_{IN}$  or directly to GND to control the current limit operation. Do not change the value of this pin when the device is enabled, and do not float this pin.

Brick-wall current limit, also known as constant current limit, is shown in [Figure 8-5](#). In this mode, once  $I_{LIM}$  is reached and the current limit circuitry has time to respond, the TPS7H1111 LDO will enter constant current regulation mode. In other words, the output voltage will drop to whatever value is needed to keep the output current at  $I_{LIM}$ . Once the fault is removed the device will resume regulation. Generally, there will be the same soft start time as during initial startup since the SS\_SET pin is pulled-low to quickly discharge the  $C_{SS}$  capacitor during a fault. However, if the fault is extremely quick, the  $C_{SS}$  capacitor may not be fully discharged which would result in a quicker startup time.

Due to the high power dissipation in brick-wall current limit, there is the possibility that the TPS7H1111 will enter thermal shutdown which causes the device to stop regulation until it cools enough to exit thermal shutdown.

**WARNING**  
 The TPS7H1111 is not intended to indefinitely remain in brick-wall current limit mode.



**Figure 8-5. Simplified Brick-Wall Current Limit Waveforms (CLM High)**

Alternatively, if CLM is low, there is turn-off current limit. The behavior is shown in [Figure 8-6](#). In turn-off current limit, if current limit,  $I_{LIM}$ , is reached, the TPS7H1111 LDO will stop regulating (after a brief delay  $\sim 28 \mu s$ ). The LDO will not resume regulation until EN is cycled (brought low then brought high).

The primary advantage of turn-off current limit is that there is no sustained high power dissipation after current limit is reached. However, the main disadvantage is that the device will not automatically resume regulation once the fault is removed. Therefore, an external monitor must determine when a fault has occurred and decide when to toggle the EN pin. This can normally be easily implemented by an existing device (such as an FPGA or microcontroller) monitoring the PG pin. If the monitor detects the PG pin deassert, it can then toggle EN to attempt to resume regulation.

When EN is being toggled from high to low to high, it must be low for at least  $t_{EN\_LOW}$  (20  $\mu s$ ). Additionally, it is recommended to not toggle EN until SS\_SET has discharged to 5% of its nominal value in order to have sufficient soft-start during restart to avoid immediately reentering current limit.

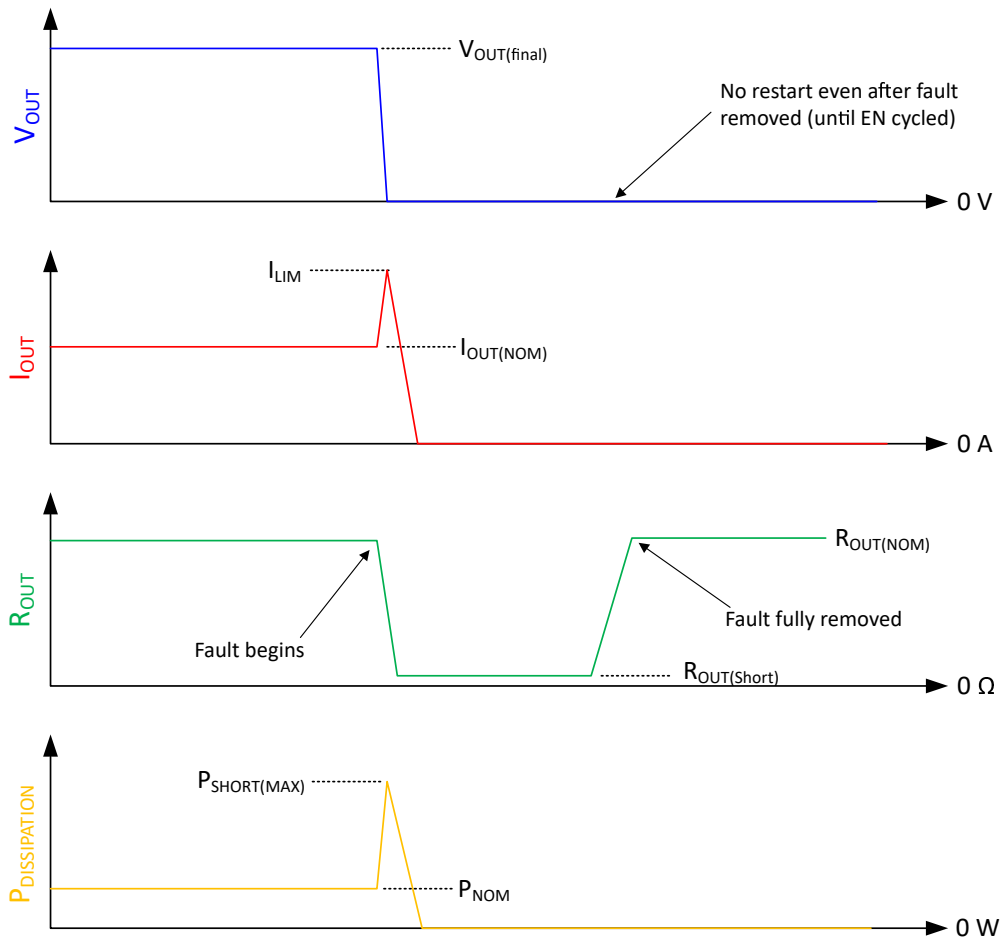


Figure 8-6. Simplified Turn-Off Current Limit Waveforms (CLM Low)

### 8.3.8 Stability

The default external compensation ( $C_{COMP} = 4.7 \text{ nF}$ ,  $R_{COMP} = 5 \text{ k}\Omega$ ) is sufficient for stability when operating within the [Recommended Operating Conditions](#) with the default range of output capacitance and parasitics.

If using the part with different output capacitance than in the [Recommended Operating Conditions](#), different compensation may be required. The main factors affecting stability is the output capacitance, its ESR (equivalent series resistance), and its ESL (equivalent series inductance). See [Section 8.3.8.2](#) for additional information.

Stability may be validated by creating a Bode plot of the control loop. This may be done by injecting a signal into the feedback path. Usually, the signal is injected across a  $5 \text{ }\Omega$  to  $50 \text{ }\Omega$  resistor between OUT and OUTS. Remove this resistor (or use a  $0 \text{ }\Omega$  shunt) when performing other measurements and during nominal operation. A common target for phase margin is  $50^\circ$  and target for gain margin is 6 dB.

#### 8.3.8.1 Output Capacitance

The TPS7H1111 is optimized for a single tantalum output capacitor of  $220 \text{ }\mu\text{F}$  or two  $100 \text{ }\mu\text{F}$  capacitors. The complete range of acceptable capacitance, ESR, and ESL are specified in the [Recommended Operating Conditions](#). Make note to verify the selected capacitors meet the requirements across all operating conditions. Additionally, a single  $0.1 \text{ }\mu\text{F}$  ceramic capacitor can be included. Place the one or more tantalum capacitors near the output of the TPS7H1111 and place the ceramic capacitor near the point of load.

ESR (equivalent series resistance) is an important parasitic element to take into account that varies significantly across frequency for capacitors. ESR values for tantalum capacitors are generally given at  $100 \text{ kHz}$ , and the values in the [Recommended Operating Conditions](#) table approximately correspond to values at  $100 \text{ kHz}$ . However, in reality the ESR at the loop crossover frequency is primarily what affects the stability of the

TPS7H1111 control loop. The loop crossover frequency can be higher or lower than 100 kHz. Therefore, the range of ESR values can be considered a good guideline, but additional verification of stability is prudent.

Also note that the capacitance, ESR, and ESL requirements are for the entire bulk capacitance. If 2x100  $\mu\text{F}$  capacitors each with 40 m $\Omega$  ESR and 2 nH ESL are used, the resulting capacitance is 200  $\mu\text{F}$  with 20 m $\Omega$  ESR and 1 nH ESL. The single ceramic capacitor should not be taken into account when considering these ESR and ESL requirements.

Ceramic capacitors larger than 0.1  $\mu\text{F}$  are generally not allowed due to their lower resonance frequency. This lower resonance frequency is likely within the loop bandwidth of the TPS7H1111 regulator (which can be nearly 10 MHz). Therefore, the low resonance point, combined with the low ESR, negatively impacts the loop bandwidth and device stability. The lower bandwidth negatively affects PSRR, therefore negating any potential benefit of additional ceramic capacitance.

However, if ceramic capacitors above 0.1  $\mu\text{F}$  must be used, it is recommended the ceramic capacitor has a resonance frequency one to two decades above the loop bandwidth. Alternatively additional series resistance can be added to increase the ESR. This prevents a strong resonance point.

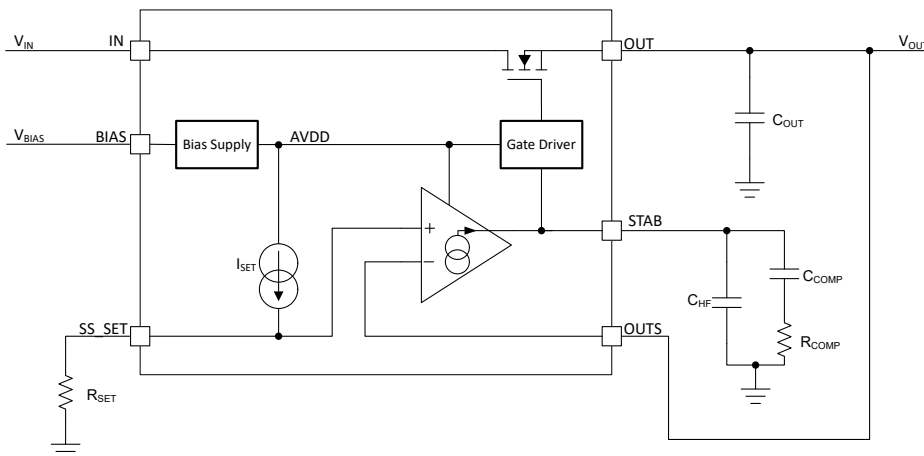
TI has measured gain and phase margin of various space grade capacitors to demonstrate good stability margin. See [Section 9.3](#) for additional information.

When capacitors other than the standard bulk capacitance and a single 0.1  $\mu\text{F}$  capacitor are utilized, it is recommended to simulate the capacitors and complete system. It is also suggested to create a Bode plot and perform load steps on the actual system to verify sufficient stability margin.

### 8.3.8.2 Compensation

It is recommended to compensate the TPS7H1111 by utilizing compensation as shown in [Figure 8-7](#) with  $C_{\text{COMP}} = 4.7 \text{ nF}$  and  $R_{\text{COMP}} = 5 \text{ k}\Omega$ .  $C_{\text{HF}}$  is not required.

However, if a different control loop response is desired, or if a different output capacitance, ESL, or ESR is used, a different compensation network may be needed. The error amplifier is an OTA (operational transconductance amplifier); therefore, [traditional compensation techniques](#) for OTAs may be employed. While TI has found its recommended type I compensation works best, an example of a type II compensation is shown in [Figure 8-7](#).



**Figure 8-7. General Type II Compensation**

Note that unlike in linear regulators that use a resistive voltage divider fed to a feedback pin, a feed forward capacitor ( $C_{\text{FF}}$ ) cannot be used to modify the control loop. For resistive voltage divider LDOs, a feed forward capacitor essentially provides a high frequency short between the output voltage and the feedback pin. However, in the TPS7H1111 architecture, there is no voltage divider and instead the output voltage is fed directly to the negative input terminal of the error amplifier. Since the error amplifier operates in a unity gain configuration, it inherently obtains the potential benefits of reduced noise and increased PSRR that a feed forward capacitor would typically provide.

### 8.3.9 Current Sharing

The TPS7H1111 supports paralleling multiple devices in order to increase the output current or spread heat dissipation. While a single device is capable of outputting 1.5 A of current, two devices are capable of outputting slightly less than 3 A. This is because each device will not source exactly 50% of the current. The mismatch in current between the two devices is due to differences in the error amplifier offset,  $V_{OS}$ , of each device. Mismatch due to differences in the reference current,  $I_{SET}$ , is removed by tying the SS\_SET nets together. This is shown in a simplified schematic in [Figure 8-8](#).

Note that an  $R_{SET}$  resistance of half the normal value should be used since there is now 200  $\mu$ A (typ) of current through the resistor. Furthermore, two  $C_{SS}$  capacitors should be utilized (or one of twice the normal value) in order to ensure equivalent start-up time. Finally, each device should have its normal output capacitance. When paralleling two devices, this results in twice the capacitance on  $V_{OUT(final)}$  when compared with a single device. The output capacitors in [Figure 8-8](#) are placed after the ballast resistor (closest to the load). This placement adds some effective ESR to the capacitors as seen by the TPS7H1111 control loop. It is also acceptable to add the capacitors before the ballast resistors directly at the OUT pins, but this may result in a slightly larger voltage drop during a load step due to the ballast resistor being placed between the output capacitors and the load.

To calculate the mismatch first between two devices, the total output current,  $I_{OUT}$ , the set output voltage,  $V_{SS\_SET}$ , the offset voltage of each device,  $V_{OS}$ , and the ballast resistor,  $R_{ballast}$ , must be known. The ballast resistor may be selected to meet the desired current matching requirements; however, it should be noted that the larger the ballast resistor, the worse the load regulation will be due to IR drops across the ballast resistor. Then, the combined output voltage,  $V_{OUT(final)}$ , must be calculated as shown in [Equation 9](#). This is the voltage that will be seen at the load.

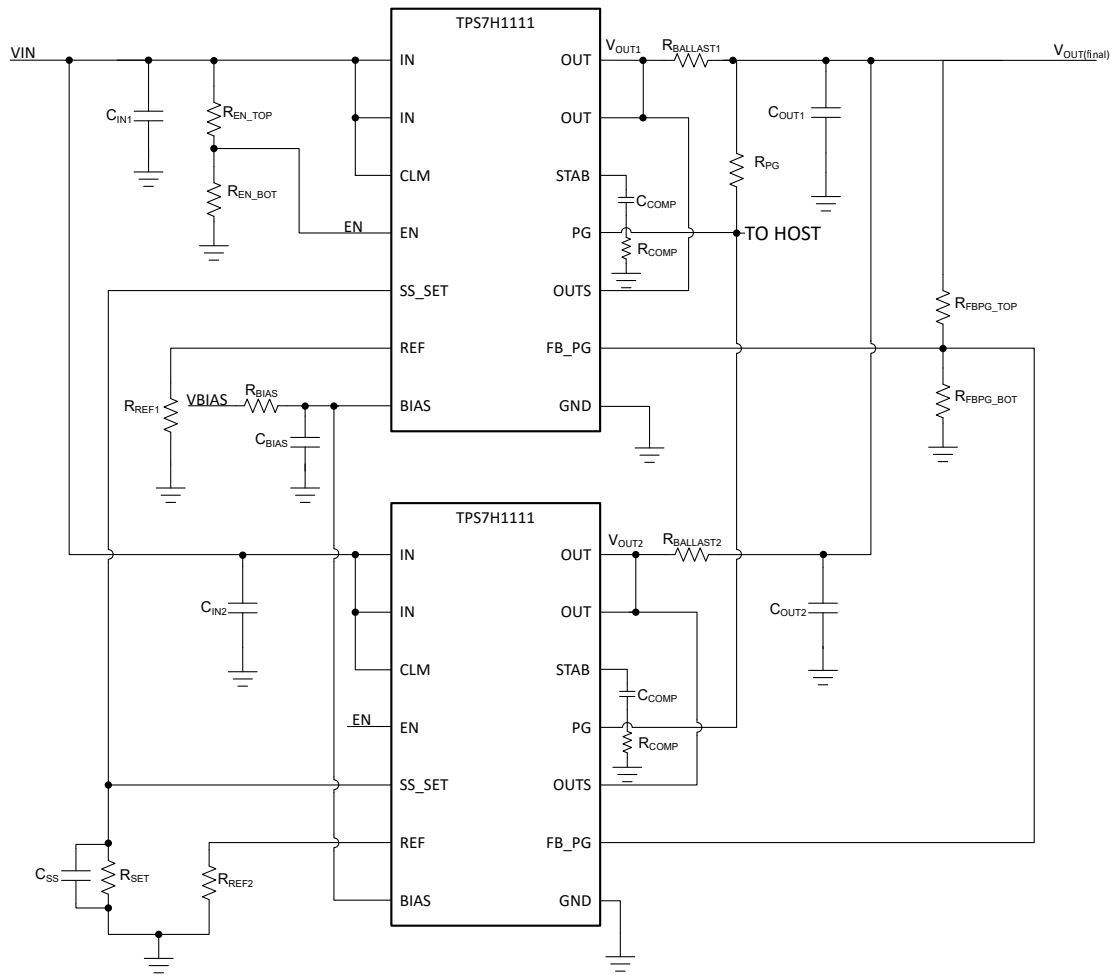
$$V_{OUT(final)} = [(V_{SS\_SET} + V_{OS1}) + (V_{SS\_SET} + V_{OS2}) - I_{OUT} \times R_{ballast}] / 2 \quad (9)$$

Next the current in each device is calculated using [Equation 10](#) and [Equation 11](#)

$$I_{OUT1} = (V_{SS\_SET} + V_{OS1} - V_{OUT(final)}) / R_{ballast} \quad (10)$$

$$I_{OUT2} = (V_{SS\_SET} + V_{OS2} - V_{OUT(final)}) / R_{ballast} \quad (11)$$

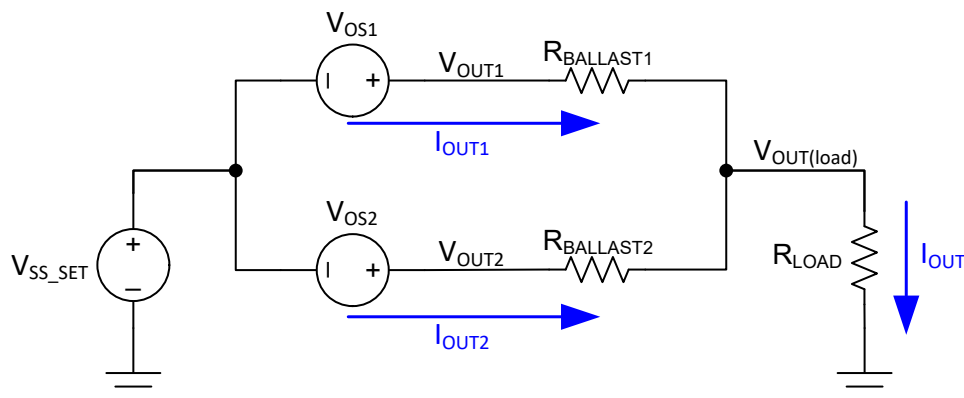
This calculated current can be compared to the ideal current through each device,  $I_{OUT(total)} / 2$ .



**Figure 8-8. Current Sharing Simplified Schematic**

Ideally the offset of each device would be measured to determine the exact current sourced by each device. As this is generally infeasible, it is often tempting to use the worst case offset shown in the [Electrical Characteristics](#). This would result in setting  $V_{OS1}$  to the maximum specified  $V_{OS}$  and  $V_{OS2}$  to the minimum specified  $V_{OS}$ . However, this may result in an overly pessimistic mismatch. To aid in analysis, histograms of multiple measured units of offset data are provided in [Figure 6-47](#), [Figure 6-48](#), and [Figure 6-49](#). Additionally, measurements have shown better than calculated results as described in [Section 9.2.2](#).

A simplified diagram showing current sharing and the source of error is given in [Figure 8-9](#).



**Figure 8-9. Current Sharing Simplified Schematic**

### 8.3.10 PSRR

The PSRR (power supply rejection ratio) of the TPS7H1111, is the amount it attenuates the input noise at  $V_{IN}$ , to the output,  $V_{OUT}$ . It is mathematically defined in [Equation 12](#).

$$PSRR = 20 \times \log(V_{IN(AC)} / V_{OUT(AC)}) \quad (12)$$

The input noise is generally dominated by the switching ripple of an upstream converter. This noise occurs at the switching frequency and its harmonics.

The PSRR values are reported under various conditions and at different frequencies in both the [Electrical Characteristics](#) and the Typical Characteristics [Figure 6-1](#) through [Figure 6-11](#). The TPS7H1111 is designed to have excellent PSRR across a wide variety of conditions. In order to further improve PSRR, operating conditions can be fine tuned. In general, the TPS7H1111 PSRR is most improved by the following (in relative order of importance):

- Increased input supply headroom (increased  $V_{IN} - V_{OUT}$ )
- Increased bias supply headroom (increased  $V_{BIAS} - V_{OUT}$ )
- Decreased output current
- Larger RC filter on the BIAS rail (only if the bias supply is the main source of noise)

PSRR is only minimally improved on the TPS7H1111 by the following:

- Increased temperature
- Increased soft start capacitance
- Addition of a ferrite bead (see [Section 9.2.1.3](#))
- Increased input voltage
- Increased output voltage

The TPS7H1111 architecture is optimized for high PSRR due to its high loop bandwidth. In order to keep the bandwidth high, the output capacitance should be within the recommended operating conditions. Traditional techniques to improved PSRR by increasing output capacitance are not valid. This is because additional capacitance could reduce the loop bandwidth of the TPS7H1111. This reduced bandwidth will degrade PSRR more than the capacitance helps.

If additional PSRR at high frequency (for example, > 10 MHz) is desired, a ferrite bead may be utilized. The ferrite bead should be placed outside the TPS7H1111 control loop as shown in [Section 9.2.1](#) as to not degrade the loop bandwidth or stability.

In addition to the PSRR from  $V_{IN}$  to  $V_{OUT}$ , PSRR is specified from  $V_{BIAS}$  to  $V_{OUT}$  as  $PSRR_{BIAS}$ . It is defined in [Equation 13](#).

$$PSRR_{BIAS} = 20 \times \log(V_{BIAS(AC)} / V_{OUT(AC)}) \quad (13)$$

Since the BIAS supply is relatively low current, an RC filter can be inserted between the BIAS supply and BIAS pin (typically 10  $\Omega$  and 4.7  $\mu$ F) to increase the  $PSRR_{BIAS}$ . The RC filter, combined with the internal ripple rejection of the internal bias regulator, provides very high  $PSRR_{BIAS}$  as shown in [Figure 6-13](#). Therefore, at typical switching frequencies between 100 kHz and 1 MHz (where high ripple rejection is the most important to filter the input ripple),  $PSRR_{BIAS}$  remains very high to avoid becoming a major limiting factor in overall device PSRR. If an RC filter is unable to be utilized, the  $PSRR_{BIAS}$  values will be degraded as shown in [Figure 6-12](#).

If the bias supply is exceptionally noisy or if an RC filter is unable to be utilized, it may be beneficial to calculate the total output ripple coming from the input ripple on both the  $V_{IN}$  and  $V_{BIAS}$  supplies. The total output ripple is the superposition of the  $V_{IN}$  ripple attenuated by its PSRR and the  $V_{BIAS}$  ripple attenuated by its  $PSRR_{BIAS}$  as shown in [Equation 14](#). Note however that each term is frequency dependent.

$$V_{OUT(AC)} = V_{IN(AC)} / (10^{PSRR/20}) + V_{BIAS(AC)} / (10^{PSRR_{BIAS}/20}) \quad (14)$$

### 8.3.11 Noise

In addition to the attenuated input noise, the TPS7H1111 (along with all physical devices) creates inherent noise. This noise is superimposed on the output signal. The noise values are also reported under various conditions and at different frequencies in both the [Electrical Characteristics](#) and the Typical Characteristics [Figure 6-15](#) through [Figure 6-19](#).

Some of the most problematic noise is the low frequency output noise (also referred to as 1/f noise). This is very difficult to filter out using discrete filters as it would require very large component values. TPS7H1111 is optimized for low noise across the frequency spectrum, particularly at low frequency. Various design techniques are utilized to achieve this such as high loop bandwidth, a unity gain error amplifier, and the use of a reference filter.

The precision current reference,  $I_{SET}$ , is filtered by the  $C_{SS}$  capacitor. Larger  $C_{SS}$  capacitance better filters  $I_{SET}$ . However, the noise reduction with larger capacitors primarily reduces the 1/f noise under 200 Hz. The noise reduction is minimal for high frequency noise. Generally a 4.7  $\mu$ F ceramic capacitor is a reasonable tradeoff between low noise, physical capacitor size, capacitor availability, and device startup time.

The TPS7H1111 has minimal difference in noise across all  $V_{OUT}$  and  $V_{IN}$  operating conditions. However, at higher output currents the noise is marginally greater at frequencies higher than 100 kHz.

Both PSRR and noise contribute to a clean output voltage. However, depending on the application, either PSRR or noise can be more important, and it is important to optimize for the given application. Generally PSRR is more important if there is substantial noise at  $V_{IN}$  (perhaps in the form of a highly noisy switching regulator).

### 8.3.12 Thermal Shutdown

The TPS7H1111 has thermal shutdown to turn-off the device when the die temperature exceeds  $T_{SD(enter)}$ . As the die cools below  $T_{SD(exit)}$ , the device will resume regulation. The typical  $T_{SD(enter)}$  of 160°C and  $T_{SD(exit)}$  of 130°C provides a large hysteresis (30°C typical). The large hysteresis is intended to allow the device to sufficiently cool before attempting to resume regulation.

## 8.4 Device Functional Modes

The table below shows the device modes.

**Table 8-4. Device Functional Modes**

EN PIN	Device Status
High	Regulation mode
Low	Shutdown mode

## 9 Application and Implementation

### Note

Information in the following applications sections is not part of the TI component specification, and TI does not warrant its accuracy or completeness. TI's customers are responsible for determining suitability of components for their purposes, as well as validating and testing their design implementation to confirm system functionality.

### 9.1 Application Information

The TPS7H1111 is a radiation hardened linear regulator optimized for RF applications. It has an output current of up to 1.5 A, and it can be used over an input voltage range of 0.85 V to 7 V with a bias supply voltage range of 2.2 V to 14 V.

### 9.2 Typical Applications

There are a wide variety of use cases for the TPS7H1111 LDO. The following are discussed in this section:

1. 2.5 V input to 1.8 V output with a configurable turn-on threshold (EN)
2. 2.5 V input to 1.8 V output parallel operation

#### 9.2.1 Application 1: Set Turn-On Threshold with EN

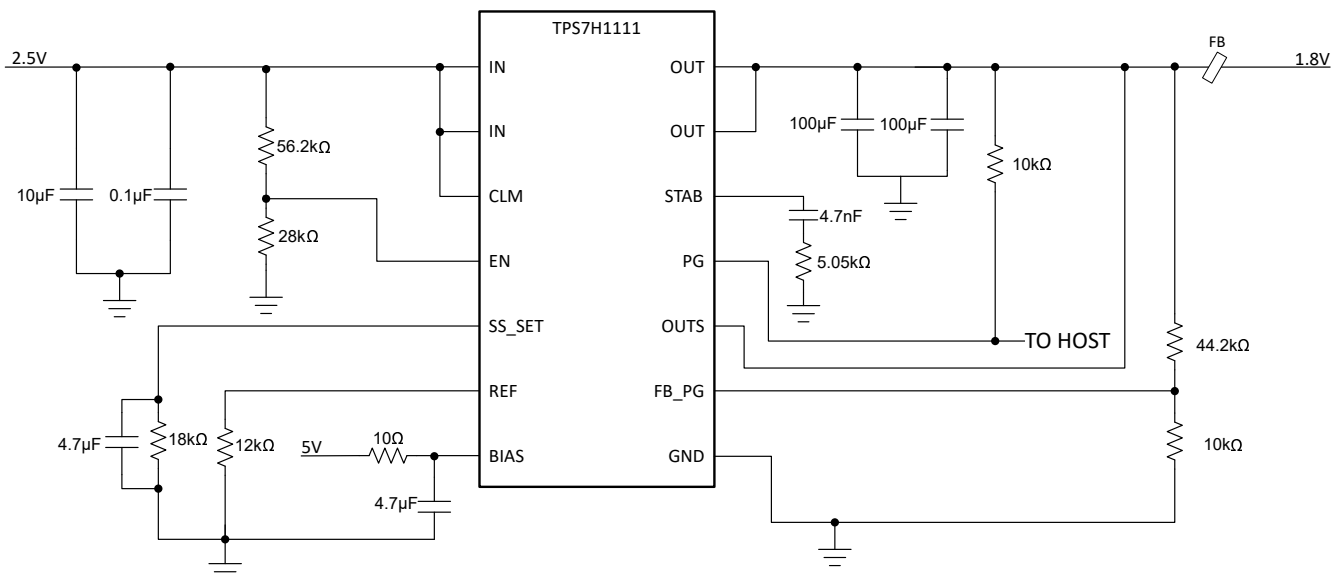


Figure 9-1. Use Case: Set Turn-On Threshold with EN

#### 9.2.1.1 Design Requirements

Table 9-1. Design Parameters

PARAMETER	VALUE
$V_{IN}$	2.5 V $\pm$ 5%
$V_{BIAS}$	5 V $\pm$ 5%
$V_{OUT}$	1.8 V $\pm$ 1.5%
$I_{OUT}$	1.4 A (typ)
$V_{IN}(\text{turn-on threshold})$	1.8 V (typ)
$V_{OUT}(\text{PG assertion threshold})$	90% of $V_{OUT}(\text{final})$ (typ), 1.62 V
$t_{SS}$	3.7 ms (typ)



### 9.2.1.2 Detailed Design Procedure

#### 9.2.1.2.1 Bias Supply

A 5 V bias supply was selected for this design. Since  $V_{BIAS} \geq V_{OUT} + 1.6 \text{ V}$ , there is sufficient bias supply headroom ( $5 \text{ V} \geq 1.8 \text{ V} + 1.6 \text{ V}$ ). Additionally, a 10  $\Omega$  resistor and 4.7  $\mu\text{F}$  X7R ceramic capacitor were selected to filter the bias supply to ensure bias supply noise is not the limiting factor in overall regulator PSRR.

#### 9.2.1.2.2 Output Voltage Configuration

The output voltage is configured using [Equation 1](#). Therefore,  $R_{SET} = V_{SS\_SET} / I_{SET} = 1.8 \text{ V} / 100 \mu\text{A} = 18 \text{ k}\Omega$ . An 18 k $\Omega$  0.1% tolerance resistor is selected. Using a 1% tolerance resistor is also acceptable, but this could contribute 1% error directly to the output voltage. Similarly, a 12 k $\Omega$  0.1% tolerance resistor is selected for  $R_{REF}$ .

#### 9.2.1.2.3 Output Voltage Accuracy

To determine the output voltage accuracy, the  $V_{ACC}$  specification with in the [Section 6.5](#) table is consulted.  $V_{ACC}$  specifies a minimum accuracy of  $-1.3\%$  and maximum accuracy of  $+1.2\%$  across temperature. This specification applies across the complete temperature range of  $-55^\circ\text{C}$  to  $125^\circ\text{C}$ , across all the input voltages ( $0.85 \text{ V} \leq V_{IN} \leq 7 \text{ V}$  and  $2.2 \text{ V} \leq V_{BIAS} \leq 14 \text{ V}$ ), and up to full load ( $1 \text{ mA} \leq I_{OUT} \leq 1.5 \text{ A}$ ). A few additional details to the measurement are noted in [Section 8.3.2](#). The following sources of error are also added to calculate a system level accuracy:

- Since post TID specifications are measured at room temperature (a MIL standard in order to avoid annealing at high temperatures), the TID drift is not part of the over temperature accuracy specification. The TPS7H1111 is specified post TID to have a minimum accuracy of  $-0.7\%$  and maximum of  $+1.1\%$ . This is compared to a pre-TID accuracy of  $-0.7\%$  and maximum of  $+0.9\%$ . Therefore, the specification increase due to TID is an additional 0.2% error being added. While the worst case TID drift of a single unit could be used instead, this may be excessively pessimistic as that would require a unit to have an initial room temperature accuracy near the maximum and a drift near the maximum values.
- The external error due to the resistor tolerance of the  $R_{REF}$  and  $R_{SET}$  resistors need to be added. Since it is assumed the error is uncorrelated, it is decided to add the errors as a sum of squares. For the selected 0.1% tolerance  $R_{REF}$  and  $R_{SET}$  resistors, the total error is  $R_{(error)} = \sqrt{0.1\%^2 + 0.1\%^2} = \pm 0.14\%$ .

[Equation 15](#) is used to calculate the system error for output voltage accuracy.

$$\text{System}_{(error)} = V_{ACC} + R_{(error)} + \text{TID}_{(error)} \quad (15)$$

Therefore, the negative error is  $\text{System}_{(error)} = -1.3\% - 0.14\% - 0\% = -1.44\%$  and the positive error is  $\text{System}_{(error)} = 1.2\% + 0.14\% + 0.2\% = 1.54\%$ . There the total system error due to the TPS7H1111 device, external resistors, and 100 krad(Si) of TID is  $+1.54\%/-1.44\%$ . If the total system error is centered, this comes to  $\pm 1.49\%$ .

Lifetime drift data could similarly be added. Group C data may be used to aid this calculation. For this example, it is assumed the lifetime drift is minimal compared to the other sources of error and is therefore not added.

#### 9.2.1.2.4 Enable Threshold

The desired turn-on threshold is 1.8 V. This means that as the  $V_{IN}$  rail is turned-on and begins rising, the TPS7H1111 will begin turning-on as soon as  $V_{IN}$  reaches 1.8 V. While this is not enough headroom from  $V_{IN}$  to  $V_{OUT}$  for final regulation, the regulator will begin start-up and  $V_{IN}$  will continue to its final voltage of 2.5 V. If desired, a higher voltage turn-on threshold could also be utilized (for example, 2.2 V).

By using [Equation 3](#) and selecting an  $R_{EN\_TOP}$  value 56.2 k $\Omega$ , the  $R_{EN\_BOT}$  resistor can be calculated as shown in [Equation 16](#).

$$R_{EN\_BOT} = V_{EN(rising)} \times R_{EN\_TOP} / (V_{IN(rising)} - V_{EN(rising)}) = 0.6 \text{ V} \times 56.2 \text{ k}\Omega / (1.8 \text{ V} - 0.6 \text{ V}) = 28.1 \text{ k}\Omega \quad (16)$$

A standard value 28 k $\Omega$  resistor is selected for  $R_{EN\_BOT}$ . The worst case (highest)  $V_{IN(rising)}$  threshold is calculated using [Equation 3](#) and the max  $V_{EN(rising)}$  threshold of 0.62 V. This is determined to be 1.86 V which is

acceptable. The typical  $V_{IN(\text{falling})}$  is then calculated using Equation 4. This is determined to be 1.50 V which is also acceptable.

It is also important to ensure Equation 5 is followed to prevent possible SEFIs. As shown in Equation 17,  $V_{EN(\text{final})} = 0.83$  V which is greater than the recommended 0.8 V.

$$V_{IN(\text{final})} \times R_{EN\_BOT} / (R_{EN\_TOP} + R_{EN\_BOT}) = V_{EN(\text{final})} = 2.5 \text{ V} \times 28 \text{ k}\Omega / (56.2 \text{ k}\Omega + 28 \text{ k}\Omega) = 0.83 \text{ V} \quad (17)$$

#### 9.2.1.2.5 Soft Start and Noise Reduction

The suggested soft start capacitor is a 4.7  $\mu\text{F}$  ceramic X7R capacitor. This is utilized for this design as it provides a reasonable soft start time of 3.7 ms and great noise filtering. A smaller  $C_{SS}$  capacitor could be selected if a slower start-up time is desired; however, a lower value capacitor is not considered in order to maintain great noise filtering of the  $I_{SET}$  reference current.

#### 9.2.1.2.6 Configurable Power Good

For this design, it is desired that the power good pin asserts when  $V_{OUT}$  reaches 90% of its final value (1.62 V).

By using Equation 7 and selecting an  $R_{FBPG\_BOT}$  value 10 k $\Omega$ , the  $R_{FBPG\_TOP}$  resistor is calculated as shown in Equation 18.

$$R_{FBPG\_TOP} = R_{FBPG\_BOT} \times (V_{OUT(\text{assert\_threshold})} - V_{FB\_PG(\text{rising})}) / V_{FBPG(\text{rising})} = [10 \text{ k}\Omega \times (1.62 \text{ V} - 0.306 \text{ V})] / 0.306 \text{ V} = 42.9 \text{ k}\Omega \quad (18)$$

A standard value 44.2 k $\Omega$  resistor is selected for  $R_{FBPG\_TOP}$ . The worst case (highest)  $V_{IN(\text{assert\_threshold})}$  threshold is then calculated in order to ensure PG is asserted (and the fast charge current is turned-off) before  $V_{OUT}$  reaches its desired value. This is determined using Equation 7 along with the maximum  $V_{FB\_PG(\text{rising})}$  threshold of 313 mV. The  $V_{OUT(\text{assert\_threshold}), \text{max}}$  value is determined to be 1.70 V. This is 94% of the final  $V_{OUT}$  value which is sufficient margin.

Finally, the typical value of the  $V_{OUT(\text{deassert\_threshold})}$  is calculated to know when PG will deassert. This is determined using Equation 8 along with the  $V_{FB\_PG(\text{hysteresis})}$  value of 14 mV. The  $V_{OUT(\text{deassert\_threshold})}$  value is determined to be 1.58 V. This means that if  $V_{OUT}$  falls to 88% of its nominal value, the PG pin will deassert.

#### 9.2.1.2.7 Current Limit

The CLM pin is connected directly to  $V_{IN}$  for brick-wall current limit mode. If desired, a resistor could also be used to pull-up the CLM pin to  $V_{IN}$  (for example, a 10 k $\Omega$  resistor).

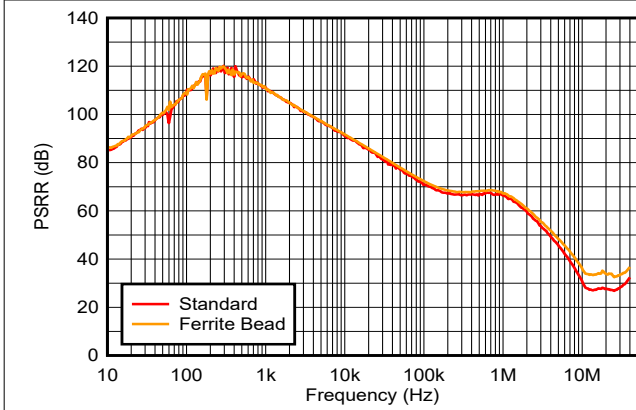
#### 9.2.1.2.8 Output Capacitor and Ferrite Bead

In accordance with the Recommended Operating Conditions, 200  $\mu\text{F}$  is selected for the output capacitance. Specifically, two 100  $\mu\text{F}$  Tantalum AVX capacitors are utilized (see Section 9.3 for a list of capacitors TI has validated for use with the TPS7H1111-SP).

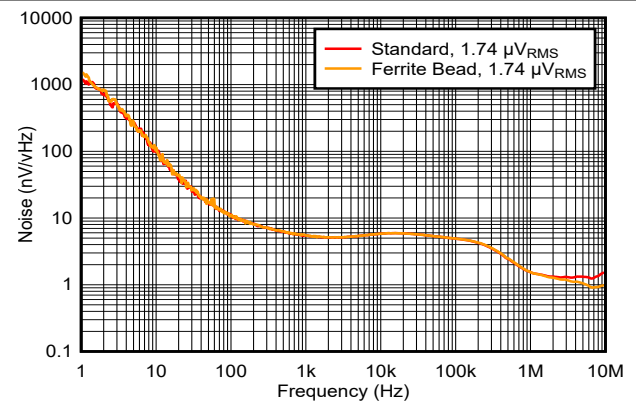
In this design a ferrite bead was also added for additional high frequency filtering. It is important to keep the OUTS connection before the ferrite bead (to keep the ferrite bead outside the TPS7H1111 control loop). If the ferrite bead was inside the control loop, the additional inductance may cause instability. In general, a ferrite bead is not required for good PSRR performance, but it was added here to determine its affects. Specifically, the KEMET Z1206C800APWST ferrite bead was selected for this design. While not utilized in this design, an additional 0.1  $\mu\text{F}$  capacitor could be placed after the ferrite bead for additional filtering.

#### 9.2.1.3 Application Curve

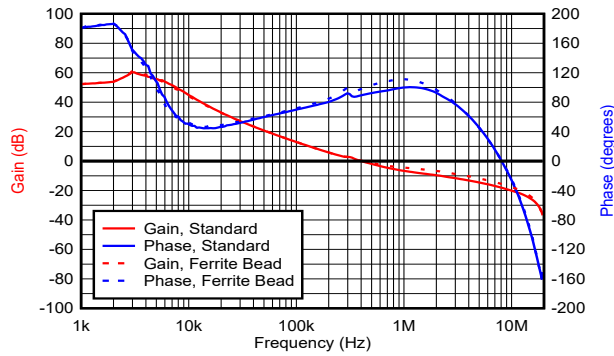
The PSRR, noise, and a Bode plot measurement is performed both with and without a ferrite bead. The measurements are done for  $V_{IN} = 2.5$  V,  $V_{OUT} = 1.8$  V,  $V_{BIAS} = 5$  V, and  $I_{OUT} = 1$  A. It is shown a ferrite bead marginally helps the higher frequency PSRR around 10 MHz. The ferrite bead shows minimal affect on noise and minimal affect on stability.



**Figure 9-2. PSRR vs. Frequency with Ferrite Bead**



**Figure 9-3. Noise vs. Frequency with Ferrite Bead**



Standard: Phase Margin = 89°, Gain Margin = 18 dB  
 Ferrite Bead: Phase Margin = 99°, Gain Margin = 16 dB

**Figure 9-4. Bode Plot with Ferrite Bead**

## 9.2.2 Application 2: Parallel Operation

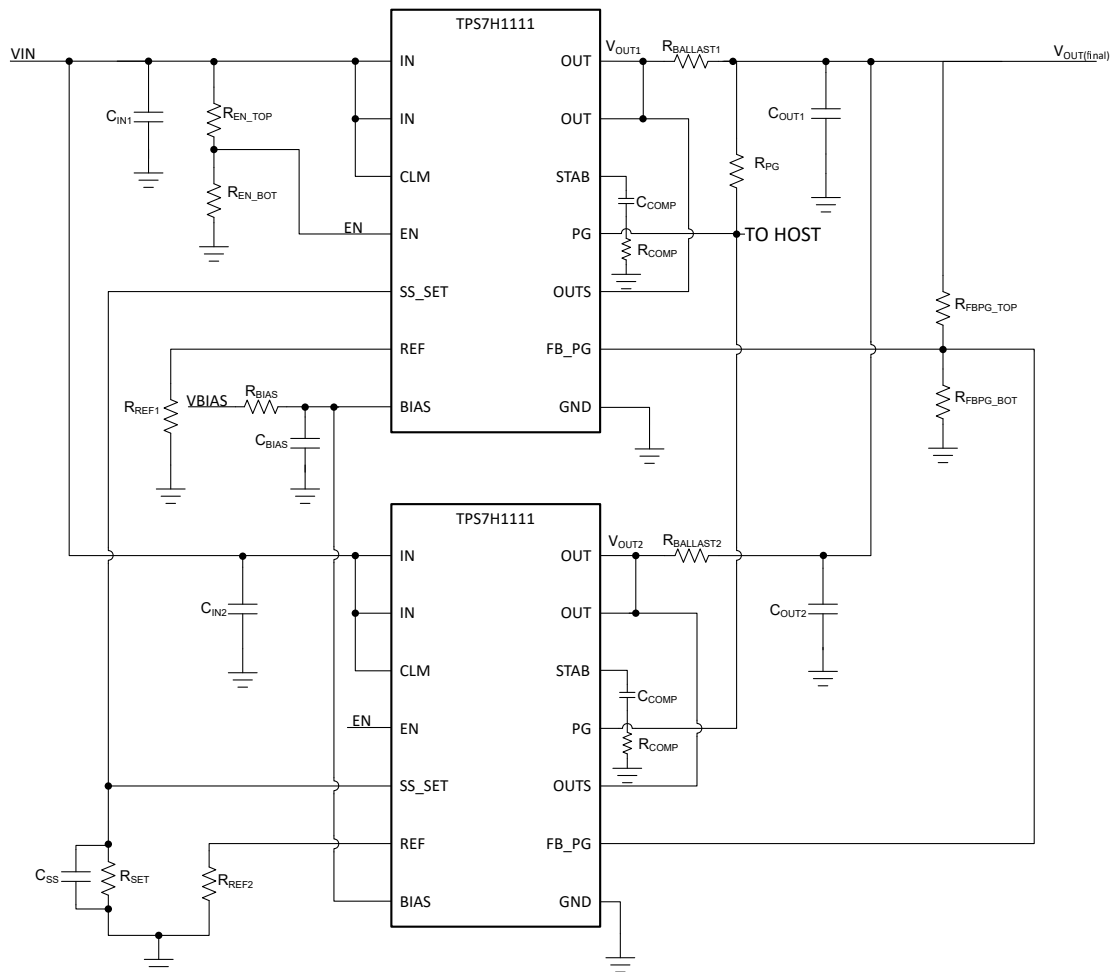


Figure 9-5. Use Case: Parallel Operation

### 9.2.2.1 Design Requirements

The design requirements shown here are similar to those in [Application 1](#). The main exception is that 2.9 A of output current is desired and a ferrite bead is not utilized. The higher current necessitates the use of paralleled devices.

Table 9-2. Design Parameters

PARAMETER	VALUE
$V_{IN}$	2.5 V $\pm$ 5%
$V_{BIAS}$	5 V $\pm$ 5%
$V_{OUT}$	1.8 V $\pm$ 1.5%
$I_{OUT}$	2.9 A
$V_{IN}(\text{turn-on threshold})$	1.8 V (typ)
$V_{OUT}(\text{PG assertion threshold})$	90% of $V_{OUT}(\text{final})$ (typ), 1.62 V
$t_{SS}$	3.7 ms (typ)

### 9.2.2.2 Detailed Design Procedure

The design procedure is the same as in [Application 1](#) with the exception of the sections below.

### 9.2.2.2.1 Current Sharing

As described in [Section 8.3.9](#), the SS\_SET pins are connected together so that each TPS7H1111 internal error amplifier sees the same voltage. A single  $R_{SET}$  resistor may be utilized of half the normal value (since there is now 200  $\mu$ A of current through the resistor). Two  $C_{SS}$  capacitors should be utilized (or one of twice the normal value) in order to ensure equivalent start-up time.

A 5 m $\Omega$   $R_{ballast}$  resistor was utilized. The board resistance from the output of one device to the common  $V_{OUT}$  rail of both devices was assumed to be significantly less than the ballast resistor and was therefore not considered to be a significant factor in calculating the total ballast resistance. This ballast resistor was selected to achieve a reasonable tradeoff between accurate current sharing and minimizing voltage drop across the resistance. If desired, the output voltage of each device could be set marginally higher to account for a voltage drop at a given current.

[Section 8.3.9](#) shows how to calculate the worst current sharing mismatch using the output offset voltage. Additional details are in the following section showing how results are measured better than expected.

### 9.2.2.3 Application Results

The offset voltage of each device was measured and determined to be  $-0.1339$  mV for the first device and  $-0.2131$  mV for the second device. [Equation 10](#) and [Equation 11](#) are used to calculate the expected error and are recorded in [Table 9-3](#) for different current values. The current is then measured to compare with the expected error value.

**Table 9-3. Current Error**

$I_{OUT(total)}$	Expected Error	Measured Error
1.156 A	1.37%	1.04%
2.878 A	0.55%	0.07%

As shown in [Table 9-3](#), the measured error is about 1.3x less than expected at 1.156 A and 7.9x less than expected at 2.878 A. This is hypothesized to be at least partially due to the temperature coefficient of  $V_{OS}$ . If one device begins sourcing more than half the total current, it will heat up more than the second device. As the device heats, the  $V_{OS}$  decreases which causes the device to source less current. This provides a type of negative feedback, therefore ensuring more equal balancing.

### 9.3 Capacitors Tested

TI has tested various space grade capacitors and measured the control loop response of the TPS7H1111 system. The effects of different capacitors is clearly shown, but in all cases stability is demonstrated across the current range. The measured gain margin (GM) in decibels and phase margins (PM) in degrees is shown in [Table 9-4](#). Results are taken with  $V_{IN} = 2.5\text{ V}$ ,  $V_{OUT} = 1.8\text{ V}$ ,  $V_{BIAS} = 5\text{ V}$  at room temperature at the indicated current levels. The Bode plots themselves are shown in [Figure 6-20](#) through [Figure 6-27](#).

**Table 9-4. Tested Space Grade Capacitors**

Manufacturer	Capacitance	Part Numbers	$I_{OUT} = 0\text{ A}$		$I_{OUT} = 1\text{ A}$		$I_{OUT} = 1.5\text{ A}$	
			PM	GM	PM	GM	PM	GM
Kemet	1x220 $\mu\text{F}$	T540D227K010AH6710	71	30	98	14	91	14
Kemet	1x220 $\mu\text{F} + 0.1\text{ }\mu\text{F}$ <sup>(1)</sup>	T540D227K010AH6710 + C0603K104K3RML	72	19	94	9	66	8
AVX	2x100 $\mu\text{F}$	TBME107K020LBLC9045	83	29	98	19	99	19
AVX	2x100 $\mu\text{F} + 0.1\text{ }\mu\text{F}$	TBME107K020LBLC9045 + 300904102104KA	61	27	98	13	99	12

(1) Not recommended for the plastic package due to the lower gain margin.

The values reported above are for the ceramic package TPS7H1111-SP. The plastic package (TPS7H1111-SP and TPS7H1111-SEP) were found to have similar stability responses but with a approximately two decibel lower gain margin. Also note that gain margin decreases at high current and low temperature. Phase margin decreases at low current and high temperature.

### 9.4 TID Effects

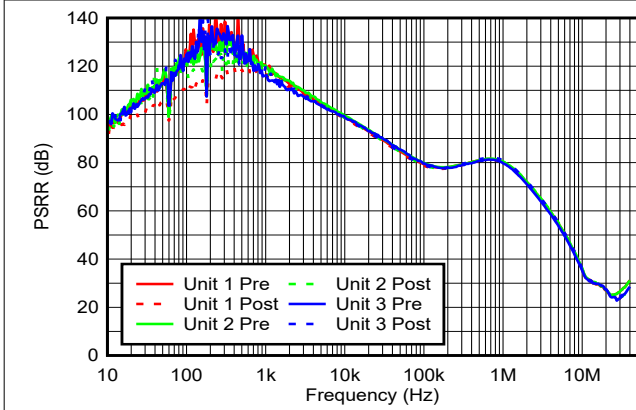
Most specifications listed in the [Electrical Characteristics](#) are tested using automated test equipment (ATE). These specifications are therefore easily tested both pre-irradiation and post-irradiation. Additionally, these specifications are generally part of the RLAT (radiation lot acceptance testing) flow. However, some specifications are difficult to measure on the ATE (such as due to high gain or sensitive to parasitics) and are therefore only measured during bench characterization. Typically these specifications are not measured post irradiation.

PSRR, noise, and stability are the key specifications that are not covered using the ATE and therefore not part of the traditional RLAT flow. In order to provide additional information for these key specifications, a one time characterization was performed on three EVMs. These three EVMs were biased and exposed at a high-dose-rate (HDR) to 100 krad(Si).

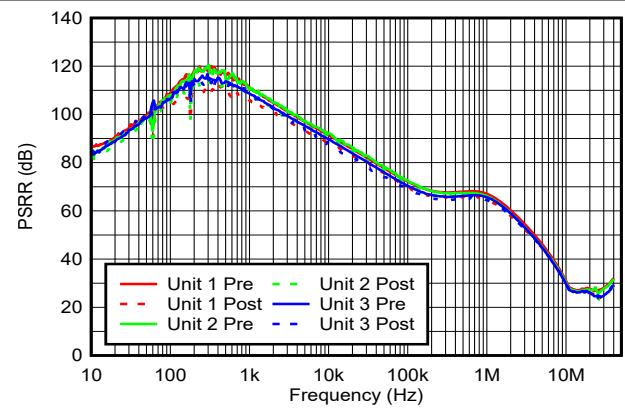
All PSRR, noise, and stability measurements showed good results under irradiation. The following generalities are made:

- PSRR is measured marginally lower post TID in the 100 Hz to 1 kHz range. Unit 1 shows around 10 dB lower post TID; however, this is thought to be a setup related issue due to difficulty in measuring such high gain. In any event, the PSRR is still extremely high (>95 dB) within this range.
- PSRR is measured marginally lower post TID under 100 Hz and above 1 kHz.
- The noise is measured incrementally higher in the 10 Hz to 10 kHz range.
- The noise is measured about the same below 10 Hz and above 100 kHz.
- The RMS noise is calculated to be an average of 120 nV<sub>RMS</sub> higher post TID.
- The average phase margin magnitude shift is around 7°. The phase margin remains high for all pre and post measurements.
- The average gain margin magnitude shift is around 2 dB. This change is considered minimal and potentially within measurement error.

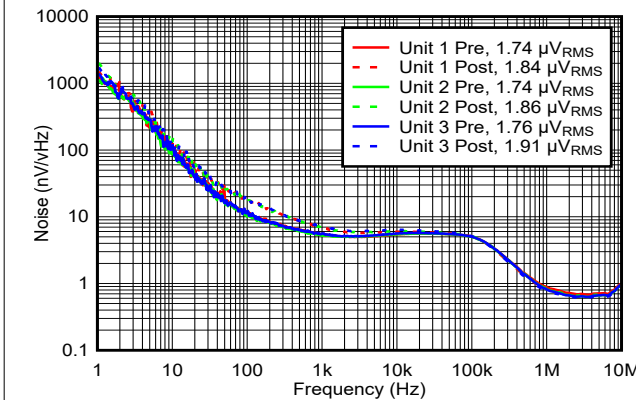
The complete data follows. Unless otherwise noted, the EVM conditions are  $V_{IN} = 2.5\text{ V}$ ,  $V_{OUT} = 1.8\text{ V}$ ,  $V_{BIAS} = 5\text{ V}$ ,  $C_{OUT} = 2x100\text{ }\mu\text{F}$  (see [Table 9-4](#)),  $C_{SS} = 4.7\text{ }\mu\text{F}$ ,  $R_{REF} = 12.0\text{ k}\Omega$ ,  $R_{BIAS} = 10\text{ }\Omega$ ,  $C_{BIAS} = 4.7\text{ }\mu\text{F}$ ,  $T_A = 25^\circ\text{C}$ , integrated noise reported with 10 Hz to 100 kHz bandwidth.



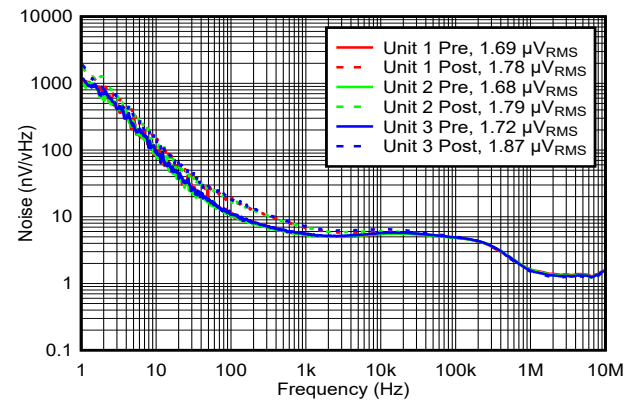
**Figure 9-6. PSRR with  $I_{OUT} = 100$  mA**



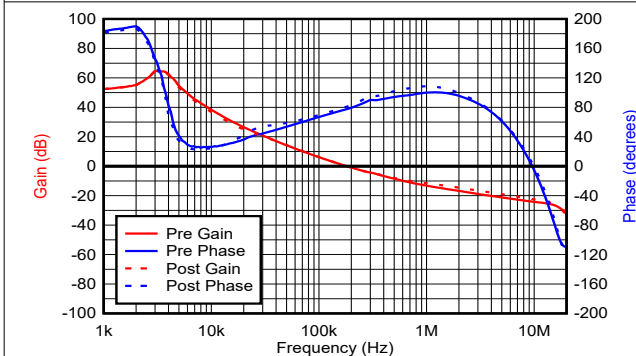
**Figure 9-7. PSRR with  $I_{OUT} = 1$  A**



**Figure 9-8. Noise Spectral Density with  $I_{OUT} = 100$  mA**

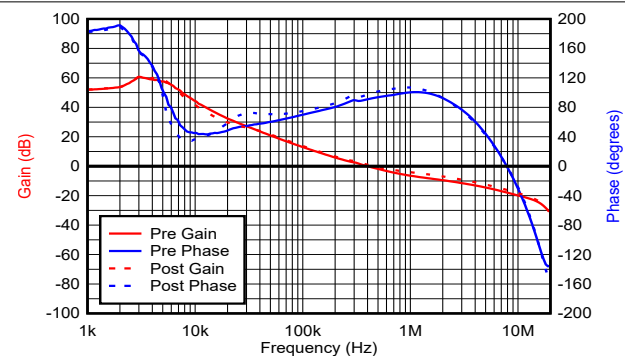


**Figure 9-9. Noise Spectral Density with  $I_{OUT} = 1$  A**



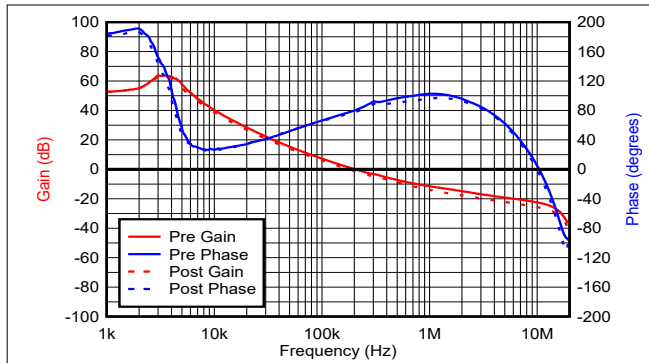
Pre-Irradiation: Phase Margin = 78°, Gain Margin = 24 dB  
Post-Irradiation: Phase Margin = 82°, Gain Margin = 23 dB

**Figure 9-10. Bode Plot: Unit 1 with  $I_{OUT} = 100$  mA**

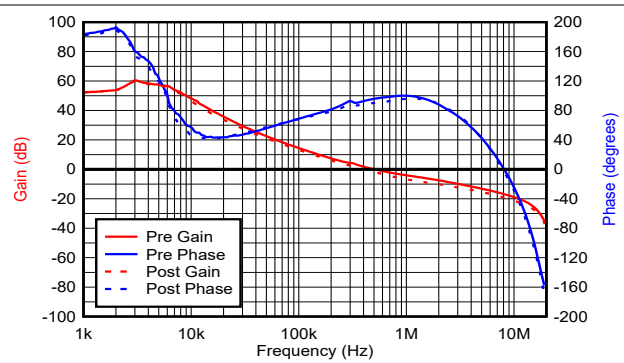


Pre-Irradiation: Phase Margin = 91°, Gain Margin = 18 dB  
Post-Irradiation: Phase Margin = 100°, Gain Margin = 16 dB

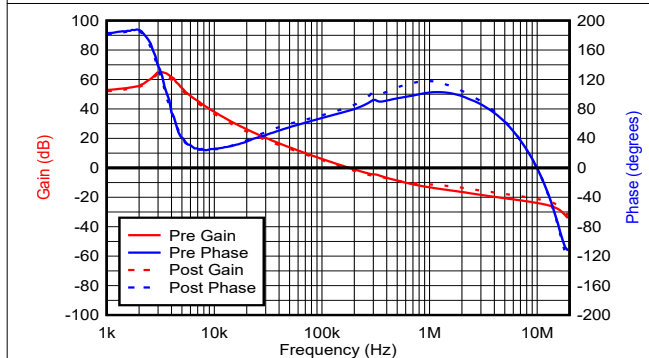
**Figure 9-11. Bode Plot: Unit 1 with  $I_{OUT} = 1$  A**



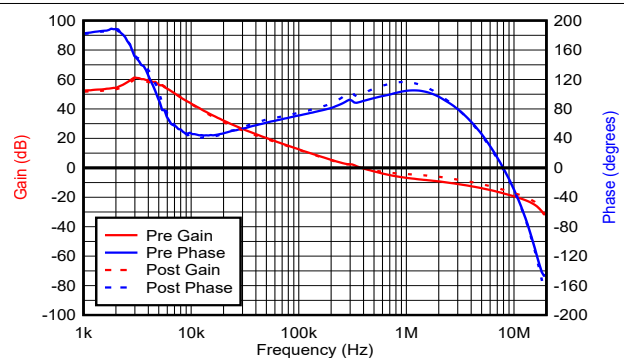
Pre-Irradiation: Phase Margin = 81°, Gain Margin = 23 dB  
 Post-Irradiation: Phase Margin = 76°, Gain Margin = 26 dB

**Figure 9-12. Bode Plot: Unit 2 with  $I_{OUT} = 100$  mA**


Pre-Irradiation: Phase Margin = 96°, Gain Margin = 17 dB  
 Post-Irradiation: Phase Margin = 88°, Gain Margin = 19 dB

**Figure 9-13. Bode Plot: Unit 2 with  $I_{OUT} = 1$  A**


Pre-Irradiation: Phase Margin = 78°, Gain Margin = 24 dB  
 Post-Irradiation: Phase Margin = 81°, Gain Margin = 21 dB

**Figure 9-14. Bode Plot: Unit 3 with  $I_{OUT} = 100$  mA**


Pre-Irradiation: Phase Margin = 90°, Gain Margin = 18 dB  
 Post-Irradiation: Phase Margin = 101°, Gain Margin = 15 dB

**Figure 9-15. Bode Plot: Unit 3 with  $I_{OUT} = 1$  A**

## 9.5 Power Supply Recommendations

This device is designed to operate with an input voltage supply from 0.85 V to 7 V. The minimum input voltage must provide adequate headroom greater than the dropout voltage for the device to have a regulated output. Additionally, a separate BIAS supply is normally used in order to reduce dropout voltage. The bias supply voltage range is from 2.2 V to 14 V (and at least as high as the input voltage supply); however, for optimal performance, it is recommended  $V_{BIAS} \geq V_{OUT} + 1.6$  V. For additional information view [Section 8.3.1](#).

The internal power dissipation during device regulation,  $P_D$ , can be approximated using [Equation 19](#).

$$P_D = I_{OUT} \times (V_{IN} - V_{OUT}) + I_{IN\_GND} \times V_{IN} + I_{BIAS} \times V_{BIAS} \quad (19)$$

The TPS7H1111 is a high-PSRR device. In order to obtain the full benefits of the high PSRR from  $V_{IN}$  to  $V_{OUT}$ , it is important that  $V_{BIAS}$  at the BIAS pin input is clean. Any ripple on the BIAS pin will couple from  $V_{BIAS}$  to  $V_{OUT}$  (reduced by  $PSRR_{BIAS}$ ). The best way to ensure BIAS sees a clean input is to add an RC filter before the BIAS pin. Due to the limited current the BIAS pin consumes, the voltage drop across the resistor is generally acceptable. A suggested value for the RC filter is  $R = 10 \Omega$  and  $C = 4.7 \mu F$ .

A bulk input capacitor of 10  $\mu F$  with a 0.1  $\mu F$  ceramic decoupling capacitor is generally sufficient for good performance. If the input supply is far away from the input of the TPS7H1111, a larger input capacitor such as 47  $\mu F$  or 100  $\mu F$  may be beneficial.

The TPS7H1111 is optimized for a single tantalum output capacitor of 220  $\mu F$  or two 100  $\mu F$  capacitors. Additionally, a single 0.1  $\mu F$  ceramic capacitor may be used. Place the tantalum capacitor(s) near the output of the TPS7H1111 and place the ceramic capacitor near the point of load. See [Section 8.3.8.1](#) for additional information.

## 9.6 Layout

### 9.6.1 Layout Guidelines

- Use traces or planes that are sized large enough to handle the input and output current with minimal voltage drop.
- Place the input capacitors close to the IN pins.
  - In some situations, the input capacitor can be placed further away from the device to minimize magnetic noise coupling.
- Place the bulk output capacitor(s) near the OUT pins.
  - If a ceramic output capacitor is used, place it near the point of load. The TPS7H1111 does not benefit from output decoupling.
- Keep high noise circuits away from SS\_SET, REF, and OUTS in order to create a clean V<sub>OUT</sub> rail.
- Ensure inductance is minimized in the TPS7H1111 feedback loop (which consists going from the OUT to the OUTS pins)

### 9.6.2 Layout Example

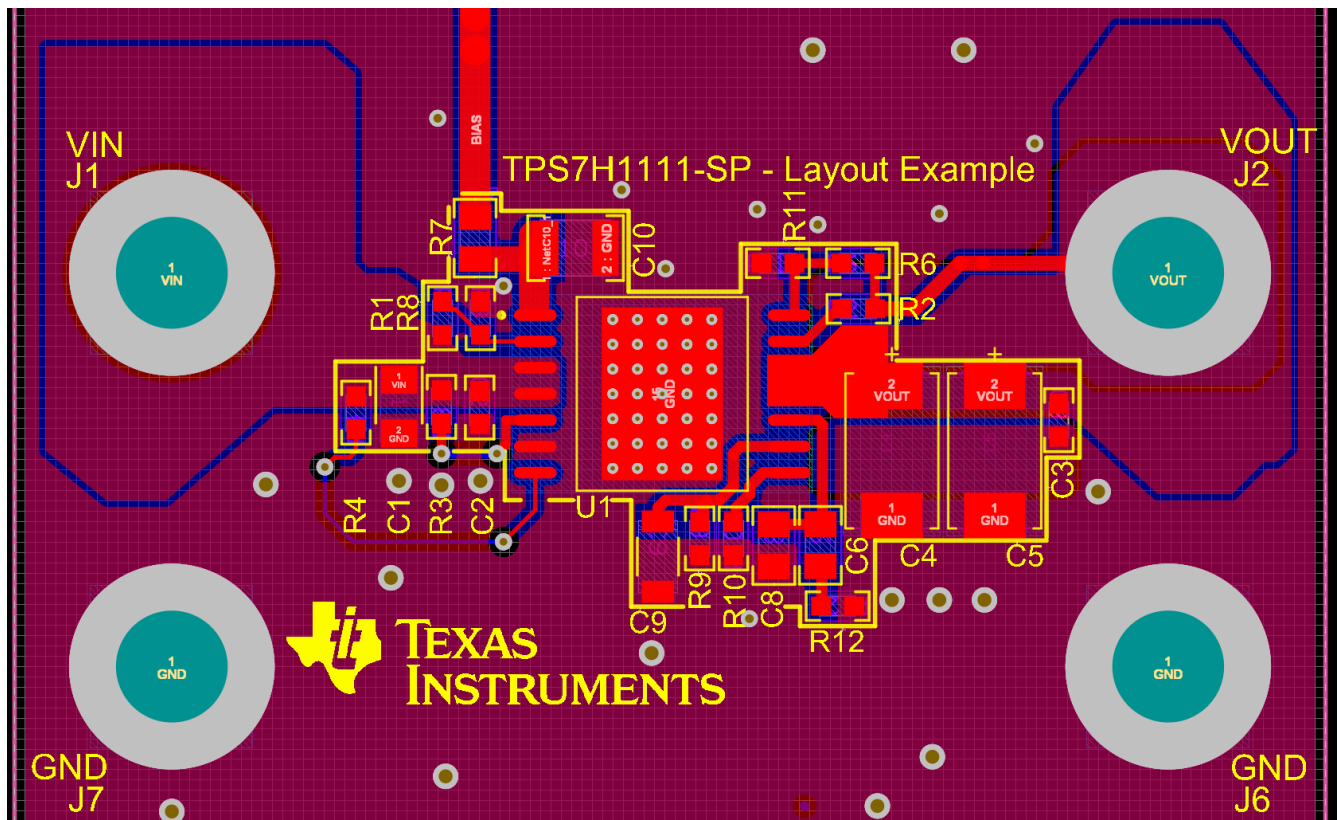


Figure 9-16. Printed Circuit Board Layout Example

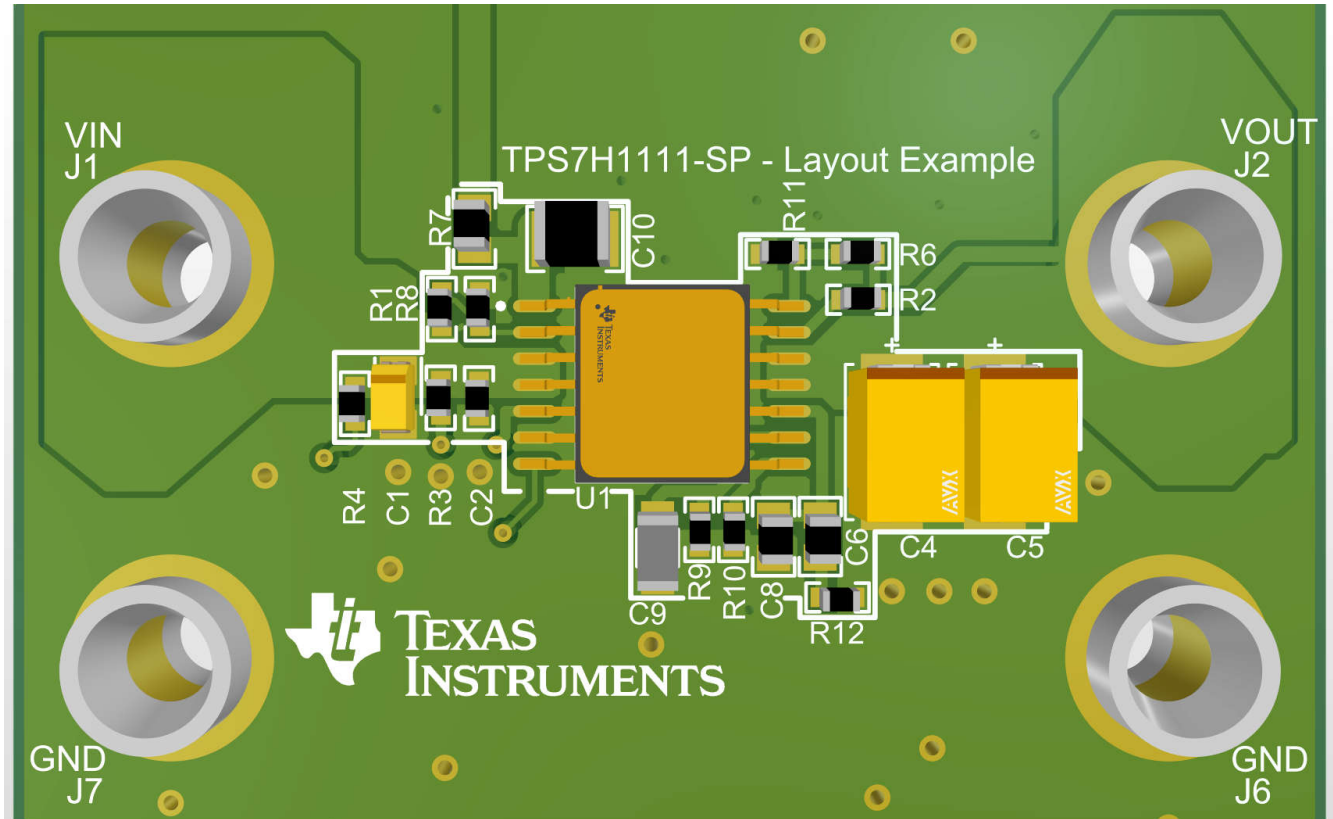


Figure 9-17. Printed Circuit Board Layout Example: 3D View

## 10 Device and Documentation Support

TI offers an extensive line of development tools. Tools and software to evaluate the performance of the device, generate code, and develop solutions are listed below.

### 10.1 Documentation Support

#### 10.1.1 Third-Party Products Disclaimer

TI'S PUBLICATION OF INFORMATION REGARDING THIRD-PARTY PRODUCTS OR SERVICES DOES NOT CONSTITUTE AN ENDORSEMENT REGARDING THE SUITABILITY OF SUCH PRODUCTS OR SERVICES OR A WARRANTY, REPRESENTATION OR ENDORSEMENT OF SUCH PRODUCTS OR SERVICES, EITHER ALONE OR IN COMBINATION WITH ANY TI PRODUCT OR SERVICE.

#### 10.1.2 Related Documentation

- [TPS7H1111-SP Total ionizing dose \(TID\) Radiation report](#)
- [TPS7H1111EVM-CVAL Evaluation Module user's guide](#)
- [Standard Microcircuit Drawing, 5962R21203](#)
- [Vendor Item Drawing, V62/23602](#)

### 10.2 Receiving Notification of Documentation Updates

To receive notification of documentation updates, navigate to the device product folder on [ti.com](#). Click on *Notifications* to register and receive a weekly digest of any product information that has changed. For change details, review the revision history included in any revised document.

### 10.3 Support Resources

[TI E2E™ support forums](#) are an engineer's go-to source for fast, verified answers and design help — straight from the experts. Search existing answers or ask your own question to get the quick design help you need.

Linked content is provided "AS IS" by the respective contributors. They do not constitute TI specifications and do not necessarily reflect TI's views; see TI's [Terms of Use](#).

### 10.4 Trademarks

TI E2E™ is a trademark of Texas Instruments.  
All trademarks are the property of their respective owners.

### 10.5 Electrostatic Discharge Caution



This integrated circuit can be damaged by ESD. Texas Instruments recommends that all integrated circuits be handled with appropriate precautions. Failure to observe proper handling and installation procedures can cause damage.

ESD damage can range from subtle performance degradation to complete device failure. Precision integrated circuits may be more susceptible to damage because very small parametric changes could cause the device not to meet its published specifications.

### 10.6 Glossary

[TI Glossary](#) This glossary lists and explains terms, acronyms, and definitions.

## 11 Revision History

NOTE: Page numbers for previous revisions may differ from page numbers in the current version.

Changes from Revision E (August 2023) to Revision F (December 2023)	Page
• Updated the nominal mass of the plastic package.....	1
• Changed 5962R2120302PYE status from "Product preview" to "Production data".....	1
• Removed known good die and associated die info.....	1
• Added orderable for "dummy" ceramic package .....	3
• Added updated thermal information for the TPS7H1111-SP QMLP version.....	7

---

**Changes from Revision D (June 2023) to Revision E (August 2023)****Page**

- Corrected Bode plots for figures 7-23, 7-25, and 7-27 in the Typical Characteristics section..... [12](#)
-

## 12 Mechanical, Packaging, and Orderable Information

The following pages include mechanical, packaging, and orderable information. This information is the most current data available for the designated devices. This data is subject to change without notice and revision of this document. For browser-based versions of this data sheet, refer to the left-hand navigation.

**PACKAGING INFORMATION**

Orderable Device	Status (1)	Package Type	Package Drawing	Pins	Package Qty	Eco Plan (2)	Lead finish/ Ball material (6)	MSL Peak Temp (3)	Op Temp (°C)	Device Marking (4/5)	Samples
5962R2120301VXC	ACTIVE	CFP	HBL	14	25	RoHS-Exempt & Green	NIAU	N / A for Pkg Type	-55 to 125	5962R2120301VXC TPS7H1111MHBLV	<a href="#">Samples</a>
5962R2120302PYE	ACTIVE	HTSSOP	PWP	28	250	RoHS & Green	NIPDAU	Level-3-260C-168 HR	-55 to 125	R2120302P	<a href="#">Samples</a>
SN0014HBL	ACTIVE	CFP	HBL	14	25	TBD	Call TI	Call TI	25 to 25	SN0014HBL-DC	<a href="#">Samples</a>
TPS7H1111HBL/EM	ACTIVE	CFP	HBL	14	25	RoHS-Exempt & Green	NIAU	N / A for Pkg Type	25 to 25	TPS7H1111HBL EVAL ONLY	<a href="#">Samples</a>
TPS7H1111MPWPTSEP	ACTIVE	HTSSOP	PWP	28	250	RoHS & Green	NIPDAU	Level-3-260C-168 HR	-55 to 125	7H1111PWP	<a href="#">Samples</a>
V62/23602-01XE	ACTIVE	HTSSOP	PWP	28	250	RoHS & Green	NIPDAU	Level-3-260C-168 HR	-55 to 125	7H1111PWP	<a href="#">Samples</a>

(1) The marketing status values are defined as follows:

**ACTIVE:** Product device recommended for new designs.

**LIFEBUY:** TI has announced that the device will be discontinued, and a lifetime-buy period is in effect.

**NRND:** Not recommended for new designs. Device is in production to support existing customers, but TI does not recommend using this part in a new design.

**PREVIEW:** Device has been announced but is not in production. Samples may or may not be available.

**OBSELETE:** TI has discontinued the production of the device.

(2) **RoHS:** TI defines "RoHS" to mean semiconductor products that are compliant with the current EU RoHS requirements for all 10 RoHS substances, including the requirement that RoHS substance do not exceed 0.1% by weight in homogeneous materials. Where designed to be soldered at high temperatures, "RoHS" products are suitable for use in specified lead-free processes. TI may reference these types of products as "Pb-Free".

**RoHS Exempt:** TI defines "RoHS Exempt" to mean products that contain lead but are compliant with EU RoHS pursuant to a specific EU RoHS exemption.

**Green:** TI defines "Green" to mean the content of Chlorine (Cl) and Bromine (Br) based flame retardants meet JS709B low halogen requirements of <=1000ppm threshold. Antimony trioxide based flame retardants must also meet the <=1000ppm threshold requirement.

(3) MSL, Peak Temp. - The Moisture Sensitivity Level rating according to the JEDEC industry standard classifications, and peak solder temperature.

(4) There may be additional marking, which relates to the logo, the lot trace code information, or the environmental category on the device.

(5) Multiple Device Markings will be inside parentheses. Only one Device Marking contained in parentheses and separated by a "-" will appear on a device. If a line is indented then it is a continuation of the previous line and the two combined represent the entire Device Marking for that device.

(6) Lead finish/Ball material - Orderable Devices may have multiple material finish options. Finish options are separated by a vertical ruled line. Lead finish/Ball material values may wrap to two lines if the finish value exceeds the maximum column width.

**Important Information and Disclaimer:**The information provided on this page represents TI's knowledge and belief as of the date that it is provided. TI bases its knowledge and belief on information provided by third parties, and makes no representation or warranty as to the accuracy of such information. Efforts are underway to better integrate information from third parties. TI has taken and continues to take reasonable steps to provide representative and accurate information but may not have conducted destructive testing or chemical analysis on incoming materials and chemicals. TI and TI suppliers consider certain information to be proprietary, and thus CAS numbers and other limited information may not be available for release.

In no event shall TI's liability arising out of such information exceed the total purchase price of the TI part(s) at issue in this document sold by TI to Customer on an annual basis.

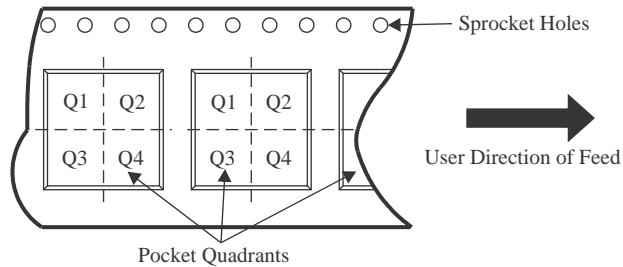
**OTHER QUALIFIED VERSIONS OF TPS7H1111-SEP, TPS7H1111-SP :**

- Catalog : [TPS7H1111-SEP](#)
- Space : [TPS7H1111-SP](#)

NOTE: Qualified Version Definitions:

- Catalog - TI's standard catalog product
- Space - Radiation tolerant, ceramic packaging and qualified for use in Space-based application

**TAPE AND REEL INFORMATION**

**QUADRANT ASSIGNMENTS FOR PIN 1 ORIENTATION IN TAPE**


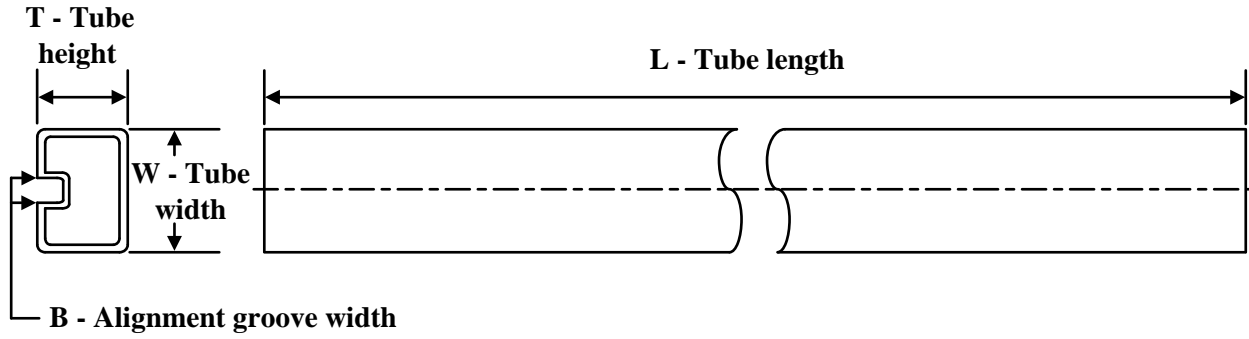
\*All dimensions are nominal

Device	Package Type	Package Drawing	Pins	SPQ	Reel Diameter (mm)	Reel Width W1 (mm)	A0 (mm)	B0 (mm)	K0 (mm)	P1 (mm)	W (mm)	Pin1 Quadrant
5962R2120302PYE	HTSSOP	PWP	28	250	178.0	16.4	6.8	10.2	1.6	8.0	16.0	Q1
TPS7H1111MPWPTSEP	HTSSOP	PWP	28	250	330.0	16.4	6.75	10.1	1.8	12.0	16.0	Q1

**TAPE AND REEL BOX DIMENSIONS**

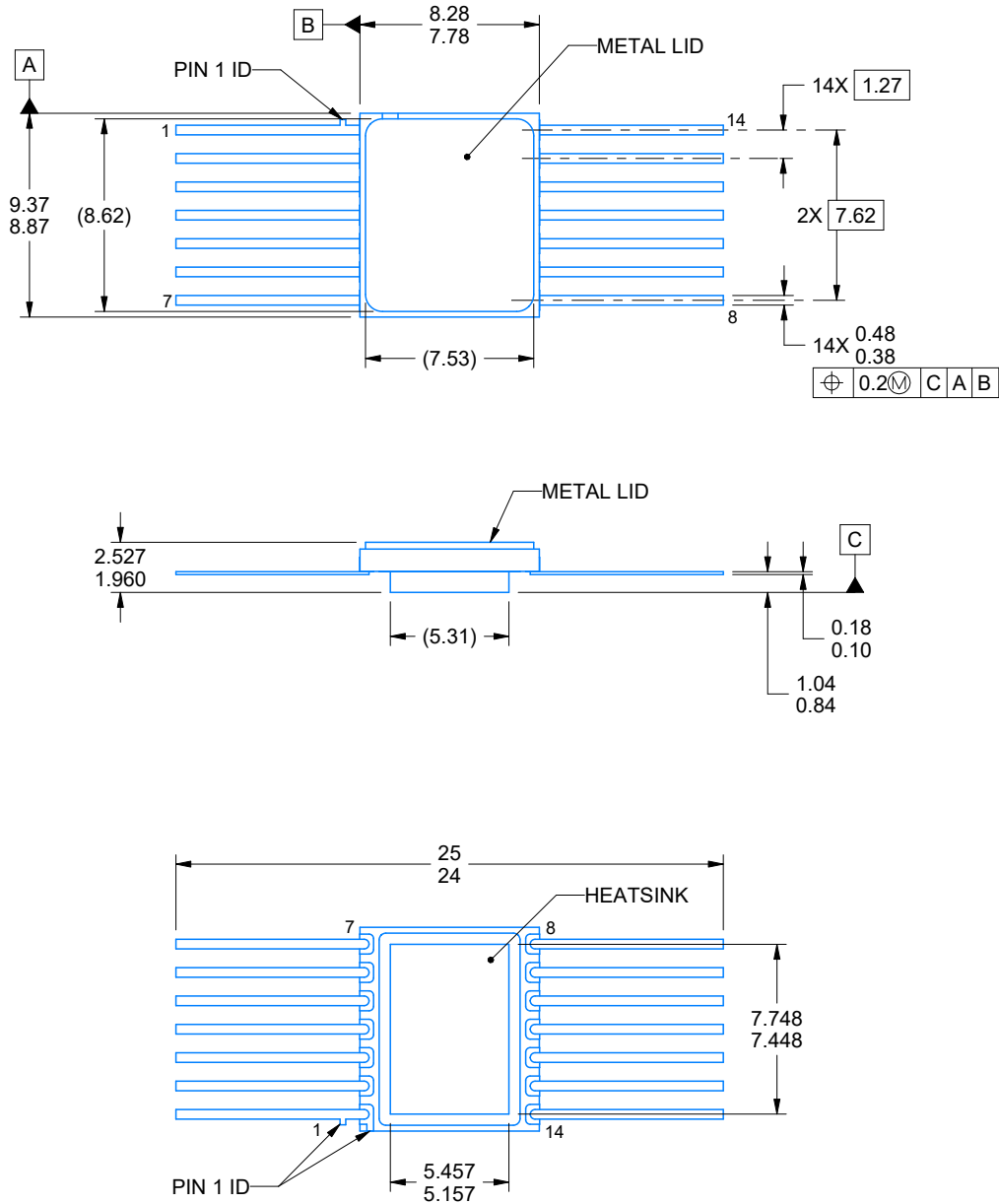
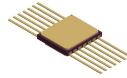

\*All dimensions are nominal

Device	Package Type	Package Drawing	Pins	SPQ	Length (mm)	Width (mm)	Height (mm)
5962R2120302PYE	HTSSOP	PWP	28	250	210.0	185.0	35.0
TPS7H1111MPWPTSEP	HTSSOP	PWP	28	250	356.0	356.0	35.0

**TUBE**


\*All dimensions are nominal

Device	Package Name	Package Type	Pins	SPQ	L (mm)	W (mm)	T (μm)	B (mm)
5962R2120301VXC	HBL	CFP	14	25	506.98	26.16	6220	NA
TPS7H1111HBL/EM	HBL	CFP	14	25	506.98	26.16	6220	NA



4226657/A 03/2021

NOTES:

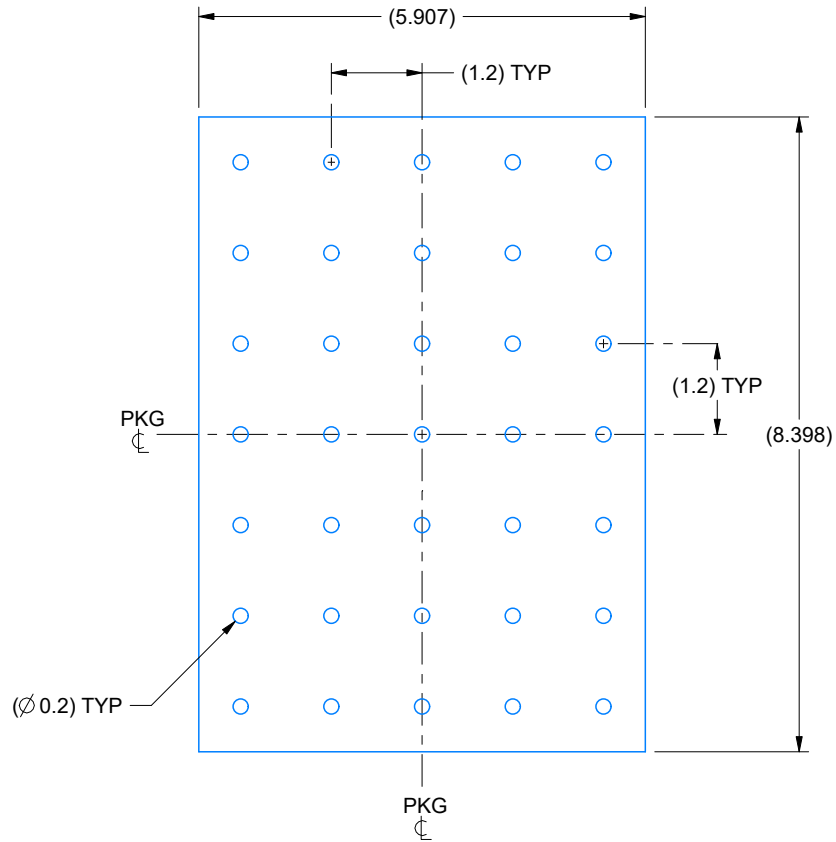
1. All linear dimensions are in millimeters. Any dimensions in parenthesis are for reference only. Dimensioning and tolerancing per ASME Y14.5M.
2. This drawing is subject to change without notice.
3. This package is hermetically sealed with a metal lid. Lid is connected to Heatsink and pin 6
4. The terminals are gold plated.

# EXAMPLE BOARD LAYOUT

HBL0014A

CFP - 2.527 mm max height

CERAMIC DUAL FLATPACK



**HEATSINK LAND PATTERN EXAMPLE**  
EXPOSED METAL SHOWN  
SCALE:10X

4226657/A 03/2021

REVISIONS

REV	DESCRIPTION	ECR	DATE	ENGINEER / DRAFTSMAN
A	RELEASE NEW DRAWING	2193915	03/24/2021	R. RAZAK / ANIS FAUZI

## GENERIC PACKAGE VIEW

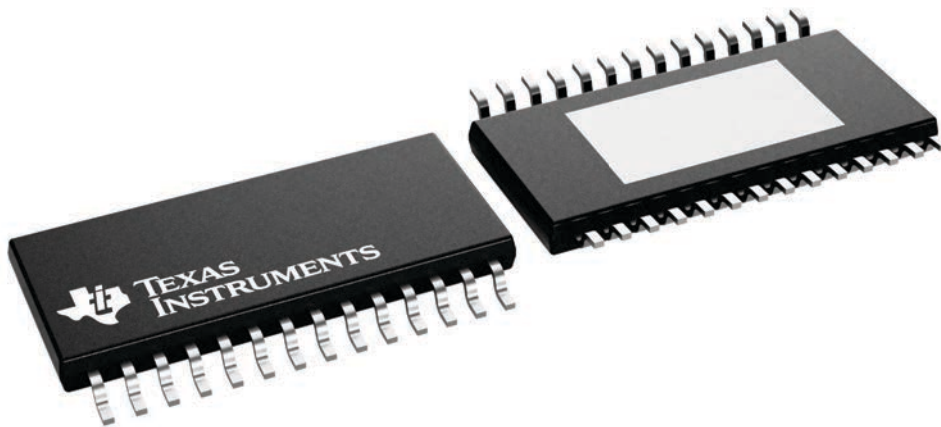
**PWP 28**

**PowerPAD™ TSSOP - 1.2 mm max height**

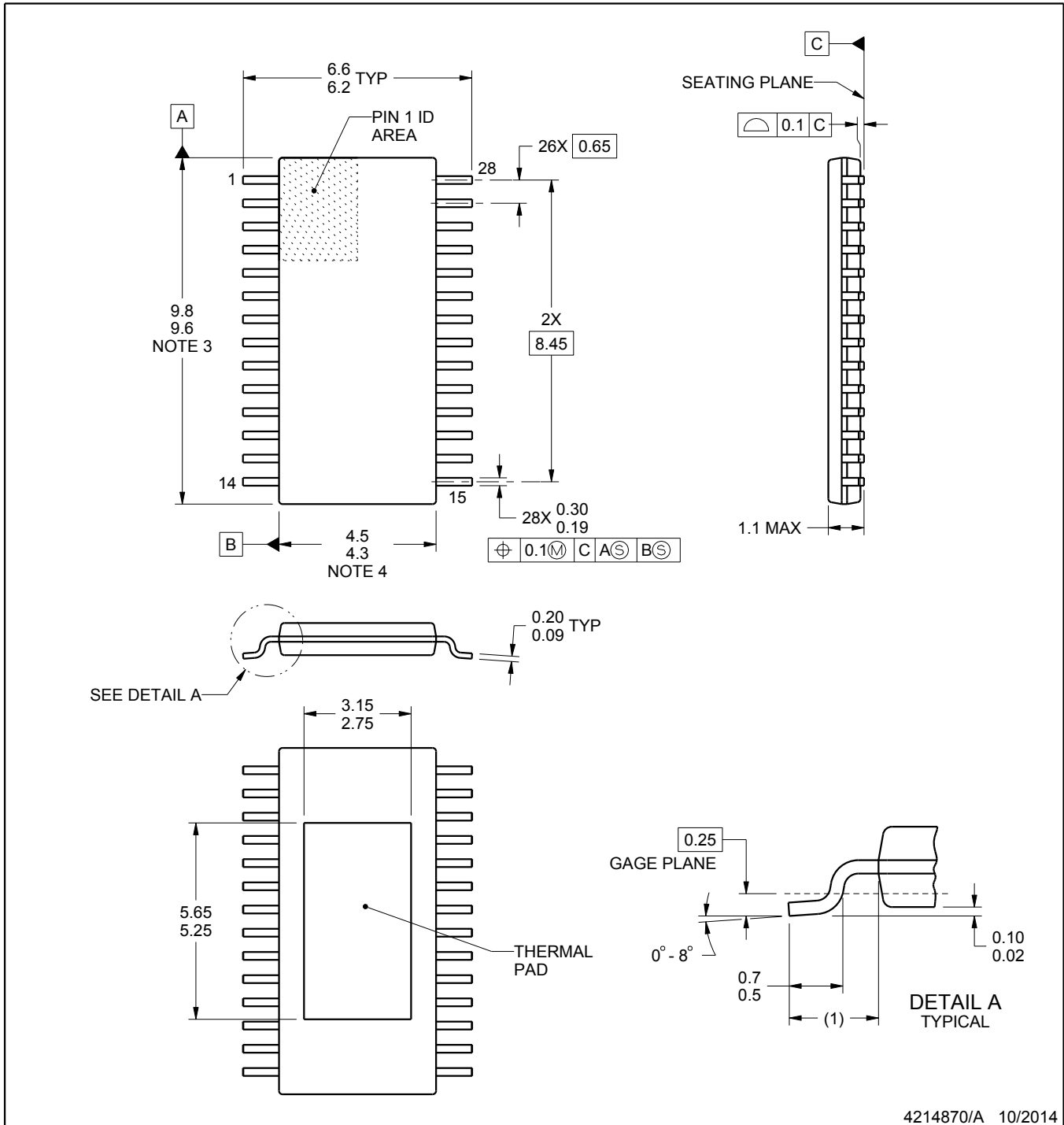
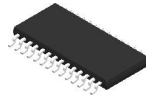
4.4 x 9.7, 0.65 mm pitch

SMALL OUTLINE PACKAGE

This image is a representation of the package family, actual package may vary.  
Refer to the product data sheet for package details.



4224765/B



4214870/A 10/2014

NOTES:

PowerPAD is a trademark of Texas Instruments.

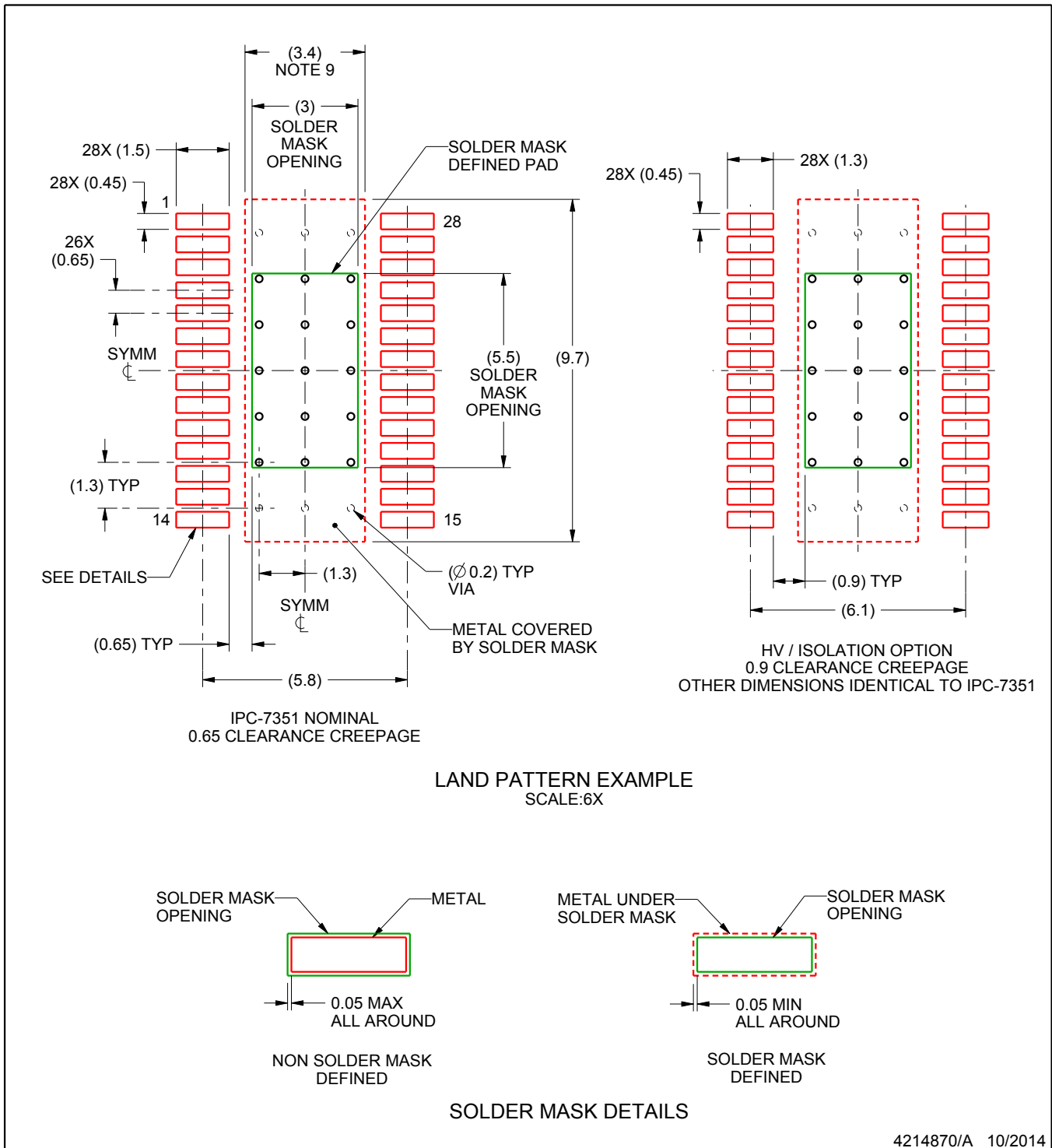
1. All linear dimensions are in millimeters. Any dimensions in parenthesis are for reference only. Dimensioning and tolerancing per ASME Y14.5M.
2. This drawing is subject to change without notice.
3. This dimension does not include mold flash, protrusions, or gate burrs. Mold flash, protrusions, or gate burrs shall not exceed 0.15 mm, per side.
4. This dimension does not include interlead flash. Interlead flash shall not exceed 0.25 mm, per side.
5. Reference JEDEC registration MO-153, variation AET.

# EXAMPLE BOARD LAYOUT

**PWP0028A**

**PowerPAD™ - 1.1 mm max height**

PLASTIC SMALL OUTLINE



NOTES: (continued)

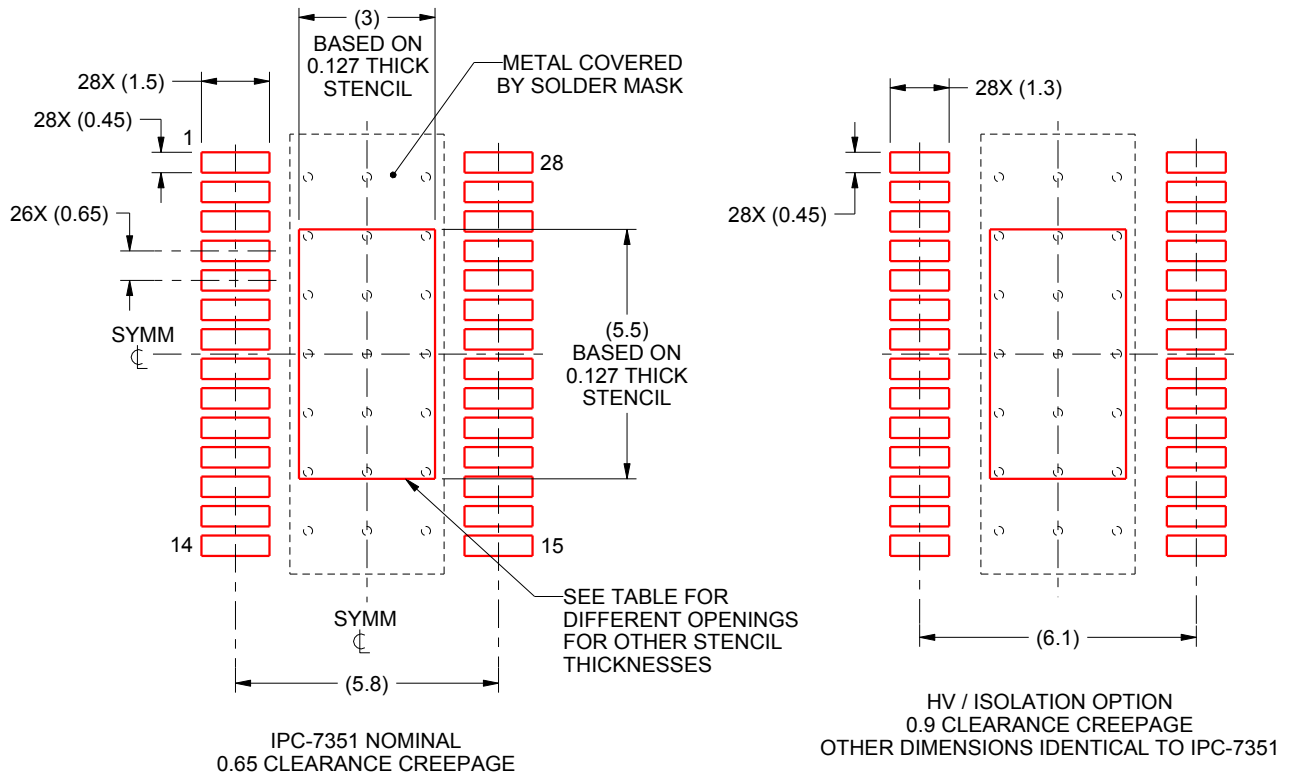
- 6. Publication IPC-7351 may have alternate designs.
- 7. Solder mask tolerances between and around signal pads can vary based on board fabrication site.
- 8. This package is designed to be soldered to a thermal pad on the board. For more information, see Texas Instruments literature numbers SLMA002 ([www.ti.com/lit/slma002](http://www.ti.com/lit/slma002)) and SLMA004 ([www.ti.com/lit/slma004](http://www.ti.com/lit/slma004)).
- 9. Size of metal pad may vary due to creepage requirement.

# EXAMPLE STENCIL DESIGN

PWP0028A

PowerPAD™ - 1.1 mm max height

PLASTIC SMALL OUTLINE



SOLDER PASTE EXAMPLE  
EXPOSED PAD  
100% PRINTED SOLDER COVERAGE AREA  
SCALE:6X

STENCIL THICKNESS	SOLDER STENCIL OPENING
0.1	3.55 X 6.37
0.127	3.0 X 5.5 (SHOWN)
0.152	2.88 X 5.16
0.178	2.66 X 4.77

4214870/A 10/2014

NOTES: (continued)

10. Laser cutting apertures with trapezoidal walls and rounded corners may offer better paste release. IPC-7525 may have alternate design recommendations.
11. Board assembly site may have different recommendations for stencil design.

## IMPORTANT NOTICE AND DISCLAIMER

TI PROVIDES TECHNICAL AND RELIABILITY DATA (INCLUDING DATA SHEETS), DESIGN RESOURCES (INCLUDING REFERENCE DESIGNS), APPLICATION OR OTHER DESIGN ADVICE, WEB TOOLS, SAFETY INFORMATION, AND OTHER RESOURCES "AS IS" AND WITH ALL FAULTS, AND DISCLAIMS ALL WARRANTIES, EXPRESS AND IMPLIED, INCLUDING WITHOUT LIMITATION ANY IMPLIED WARRANTIES OF MERCHANTABILITY, FITNESS FOR A PARTICULAR PURPOSE OR NON-INFRINGEMENT OF THIRD PARTY INTELLECTUAL PROPERTY RIGHTS.

These resources are intended for skilled developers designing with TI products. You are solely responsible for (1) selecting the appropriate TI products for your application, (2) designing, validating and testing your application, and (3) ensuring your application meets applicable standards, and any other safety, security, regulatory or other requirements.

These resources are subject to change without notice. TI grants you permission to use these resources only for development of an application that uses the TI products described in the resource. Other reproduction and display of these resources is prohibited. No license is granted to any other TI intellectual property right or to any third party intellectual property right. TI disclaims responsibility for, and you will fully indemnify TI and its representatives against, any claims, damages, costs, losses, and liabilities arising out of your use of these resources.

TI's products are provided subject to [TI's Terms of Sale](#) or other applicable terms available either on [ti.com](https://www.ti.com) or provided in conjunction with such TI products. TI's provision of these resources does not expand or otherwise alter TI's applicable warranties or warranty disclaimers for TI products.

TI objects to and rejects any additional or different terms you may have proposed.

Mailing Address: Texas Instruments, Post Office Box 655303, Dallas, Texas 75265  
Copyright © 2024, Texas Instruments Incorporated