

## Dual Voltage Detector With Adjustable Hysteresis

Check for Samples: [TPS3806I33-Q1](#)

### FEATURES

- Qualified for Automotive Applications
- AEC-Q100 Qualified With the Following Results:
  - Device Temperature Grade 1: –40°C to 125°C Ambient Operating Temperature Range
  - Device HBM ESD Classification Level H2
  - Device CDM ESD Classification Level C4B
- Dual Voltage Detector With Adjustable Hysteresis, 3.3-V Adjustable and 2-V Adjustable
- Assured Reset at  $V_{DD} = 0.8\text{ V}$
- Supply Current: 3  $\mu\text{A}$  Typical at  $V_{DD} = 3.3\text{ V}$
- Independent Open-Drain Reset Outputs
- 6-Pin SOT-23 Package

### APPLICATIONS

- Voltage Supervisor
- Voltage Detector
- Battery Monitor

### DESCRIPTION

The TPS3806I33-Q1 integrates two independent voltage detectors for battery voltage monitoring. During power on, the device asserts  $\overline{\text{RESET}}$  and  $\overline{\text{RSTSENSE}}$  when supply voltage  $V_{DD}$  or the voltage at the LSENSE input becomes higher than 0.8 V. Thereafter, the supervisory circuit monitors  $V_{DD}$  and LSENSE, keeping  $\overline{\text{RESET}}$  and  $\overline{\text{RSTSENSE}}$  active as long as  $V_{DD}$  and LSENSE remain below the threshold voltage,  $V_{IT}$ . As soon as  $V_{DD}$  or LSENSE rises above the threshold voltage  $V_{IT}$ , the device deasserts  $\overline{\text{RESET}}$  or  $\overline{\text{RSTSENSE}}$ , respectively. The TPS3806I33-Q1 device has a fixed-sense threshold voltage  $V_{IT}$  set by an internal voltage divider at  $V_{DD}$  and an adjustable second-LSENSE input. In addition, one can set an upper voltage threshold at HSENSE to allow a wide adjustable hysteresis window.

The devices are available in a 6-pin SOT-23 package. Characterization of the TPS3806I33-Q1 device is for operation over a temperature range of –40°C to 125°C.

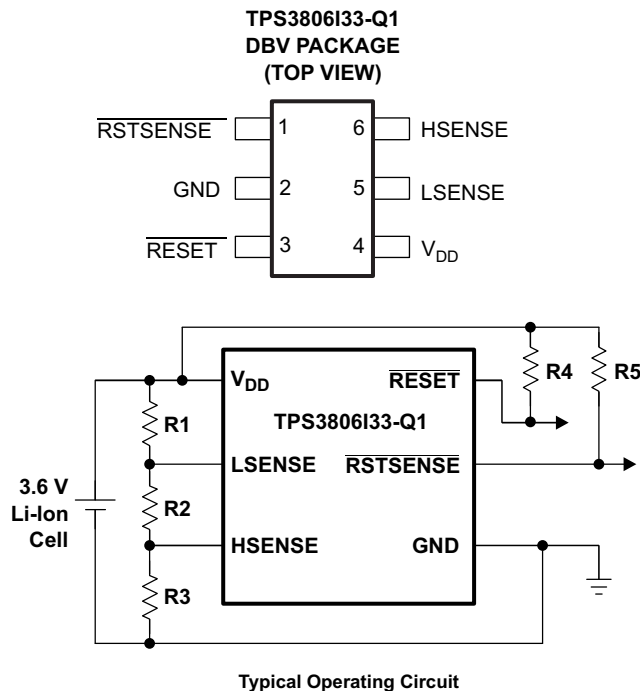

Please be aware that an important notice concerning availability, standard warranty, and use in critical applications of Texas Instruments semiconductor products and disclaimers thereto appears at the end of this data sheet.



This integrated circuit can be damaged by ESD. Texas Instruments recommends that all integrated circuits be handled with appropriate precautions. Failure to observe proper handling and installation procedures can cause damage.

ESD damage can range from subtle performance degradation to complete device failure. Precision integrated circuits may be more susceptible to damage because very small parametric changes could cause the device not to meet its published specifications.

**Table 1. ORDERING INFORMATION<sup>(1)</sup>**

T <sub>A</sub>	PACKAGE	QUANTITY	PART NUMBER	TOP-SIDE SYMBOL	STATUS
-40°C to 125°C	DBV (SOT-23)	Reel of 3000	TPS3806I33QDBVRQ1	PZHQ	Active

(1) For the most-current package and ordering information, see the Package Option Addendum located at the end of this data sheet or refer to the TI Web site at [www.ti.com](http://www.ti.com).

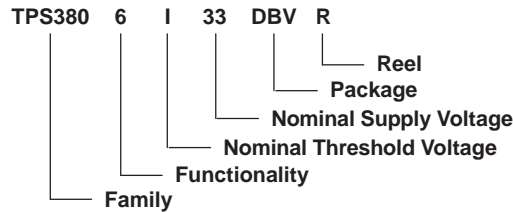

**ABSOLUTE MAXIMUM RATINGS**

over operating free-air temperature range (unless otherwise noted)<sup>(1)</sup>

	TPS3806I33-Q1	UNIT
Supply voltage, V <sub>DD</sub> <sup>(2)</sup>	7	V
All other pins <sup>(2)</sup>	-0.3 to 7	V
Maximum low-output current, I <sub>OL</sub>	5	mA
Maximum high-output current, I <sub>OH</sub>	-5	mA
Input clamp current, I <sub>IK</sub> (V <sub>I</sub> < 0 or V <sub>I</sub> > V <sub>DD</sub> )	±10	mA
Output clamp current, I <sub>OK</sub> (V <sub>O</sub> < 0 or V <sub>O</sub> > V <sub>DD</sub> )	±10	mA
Operating free-air temperature range, T <sub>A</sub>	-40 to 125	°C
Storage temperature range, T <sub>stg</sub>	-65 to 150	°C
Electrostatic discharge rating, ESD	Human-body model (HBM) AEC-Q100 Classification Level H2	2 kV
	Charged-device model (CDM) AEC-Q100 Classification Level C4B	750 V

- (1) Stresses beyond those listed under *Absolute Maximum Ratings* may cause permanent damage to the device. These are stress ratings only, and functional operation of the device at these or any other conditions beyond those indicated under *Recommended Operating Conditions* is not implied. Exposure to absolute-maximum-rated conditions for extended periods may affect device reliability.
- (2) All voltage values are with respect to GND. For reliable operation, the device must not be continuously operated at 7 V for more than t = 1000 h.

## THERMAL INFORMATION

THERMAL METRIC <sup>(1)</sup>		TPS3806I33-Q1	
		DBV	
		6 PINS	
			UNIT
$\theta_{JA}$	Junction-to-ambient thermal resistance <sup>(2)</sup>	188.9	°C/W
$\theta_{JcTop}$	Junction-to-case (top) thermal resistance <sup>(3)</sup>	130.9	°C/W
$\theta_{JB}$	Junction-to-board thermal resistance <sup>(4)</sup>	34.2	°C/W
$\psi_{JT}$	Junction-to-top characterization parameter <sup>(5)</sup>	25.4	°C/W
$\psi_{JB}$	Junction-to-board characterization parameter <sup>(6)</sup>	33.8	°C/W
$\theta_{JcBot}$	Junction-to-case (bottom) thermal resistance <sup>(7)</sup>	N/A	°C/W

- (1) For more information about traditional and new thermal metrics, see the *IC Package Thermal Metrics* application report, [SPRA953](#).
- (2) The junction-to-ambient thermal resistance under natural convection is obtained in a simulation on a JEDEC-standard, high-K board, as specified in JESD51-7, in an environment described in JESD51-2a.
- (3) The junction-to-case (top) thermal resistance is obtained by simulating a cold plate test on the package top. No specific JEDEC-standard test exists, but a close description can be found in the ANSI SEMI standard G30-88.
- (4) The junction-to-board thermal resistance is obtained by simulating in an environment with a ring cold plate fixture to control the PCB temperature, as described in JESD51-8.
- (5) The junction-to-top characterization parameter,  $\psi_{JT}$ , estimates the junction temperature of a device in a real system and is extracted from the simulation data for obtaining  $\theta_{JA}$ , using a procedure described in JESD51-2a (sections 6 and 7).
- (6) The junction-to-board characterization parameter,  $\psi_{JB}$ , estimates the junction temperature of a device in a real system and is extracted from the simulation data for obtaining  $\theta_{JA}$ , using a procedure described in JESD51-2a (sections 6 and 7).
- (7) The junction-to-case (bottom) thermal resistance is obtained by simulating a cold plate test on the exposed (power) pad. No specific JEDEC standard test exists, but a close description can be found in the ANSI SEMI standard G30-88.

## RECOMMENDED OPERATING CONDITIONS

	MIN	MAX	UNIT
Supply voltage, $V_{DD}$	1.3	6	V
Input voltage, $V_I$	0	$V_{DD} + 0.3$	V
Operating free-air temperature range, $T_A$	-40	125	°C

## ELECTRICAL CHARACTERISTICS

over recommended operating free-air temperature range (unless otherwise noted)

PARAMETER		TEST CONDITIONS	MIN	TYP	MAX	UNIT	
V <sub>OL</sub>	Low-level output voltage	V <sub>DD</sub> = 1.5 V, I <sub>OL</sub> = 1 mA				V	
		V <sub>DD</sub> = 3.3 V, I <sub>OL</sub> = 2 mA			0.3		
		V <sub>DD</sub> = 6 V, I <sub>OL</sub> = 3 mA					
Power-up reset voltage <sup>(1)</sup>		V <sub>DD</sub> ≥ 0.8 V, I <sub>OL</sub> = 50 μA			0.2	V	
V <sub>IT</sub>	Negative-going input threshold voltage <sup>(2)</sup>	LSENSE	T <sub>A</sub> = 25°C	1.198	1.207	1.216	V
		TPS3806I33-Q1		2.978	3	3.022	
		LSENSE	T <sub>A</sub> = 0°C to 70°C	1.188	1.207	1.226	
		TPS3806I33-Q1		2.952	3	3.048	
		LSENSE	T <sub>A</sub> = -40°C to 125°C	1.183	1.207	1.231	
TPS3806I33-Q1	2.94	3		3.06			
V <sub>hys</sub>	Hysteresis	1.2 V < V <sub>IT</sub> < 2.5 V		60		mV	
		2.5 V < V <sub>IT</sub> < 3.5 V		90			
I <sub>I</sub>	Input current	LSENSE, HSENSE	-25		25	nA	
I <sub>OH</sub>	High-level output current	V <sub>DD</sub> = V <sub>IT</sub> + 0.2 V, V <sub>OH</sub> = V <sub>DD</sub>			300	nA	
I <sub>DD</sub>	Supply current	V <sub>DD</sub> = 3.3 V, output unconnected		3	5	μA	
		V <sub>DD</sub> = 6 V, output unconnected		4	6		
C <sub>i</sub>	Input capacitance	V <sub>I</sub> = 0 V to V <sub>DD</sub>		1		pF	

(1) The lowest supply voltage at which  $\overline{\text{RESET}}$  becomes active.  $t_{r, V_{DD}} \geq 15 \mu\text{s/V}$

(2) To ensure best stability of the threshold voltage, place a bypass capacitor (ceramic, 0.1 μF) near the supply terminals.

## SWITCHING CHARACTERISTICS

at R<sub>L</sub> = 1 MΩ, C<sub>L</sub> = 50 pF, T<sub>A</sub> = -40°C to 125°C

PARAMETER		TEST CONDITIONS	MIN	TYP	MAX	UNIT
t <sub>PHL</sub>	Propagation (delay) time, high-to-low-level output	V <sub>DD</sub> to $\overline{\text{RESET}}$ delay	V <sub>IH</sub> = 1.05 × V <sub>IT</sub> , V <sub>IL</sub> = 0.95 × V <sub>IT</sub>	5	100	μs
		LSENSE to $\overline{\text{RSTSENSE}}$ delay				
t <sub>PLH</sub>	Propagation (delay) time, low-to-high-level output	V <sub>DD</sub> to $\overline{\text{RESET}}$ delay				
		HSENSE to $\overline{\text{RSTSENSE}}$ delay				

## TIMING REQUIREMENTS

at R<sub>L</sub> = 1 MΩ, C<sub>L</sub> = 50 pF, T<sub>A</sub> = -40°C to 125°C

PARAMETER		TEST CONDITIONS	MIN	TYP	MAX	UNIT
t <sub>w</sub>	Pulse duration	At V <sub>DD</sub>	V <sub>IH</sub> = 1.05 × V <sub>IT</sub> , V <sub>IL</sub> = 0.95 × V <sub>IT</sub>	5.5		μs
		At SENSE				

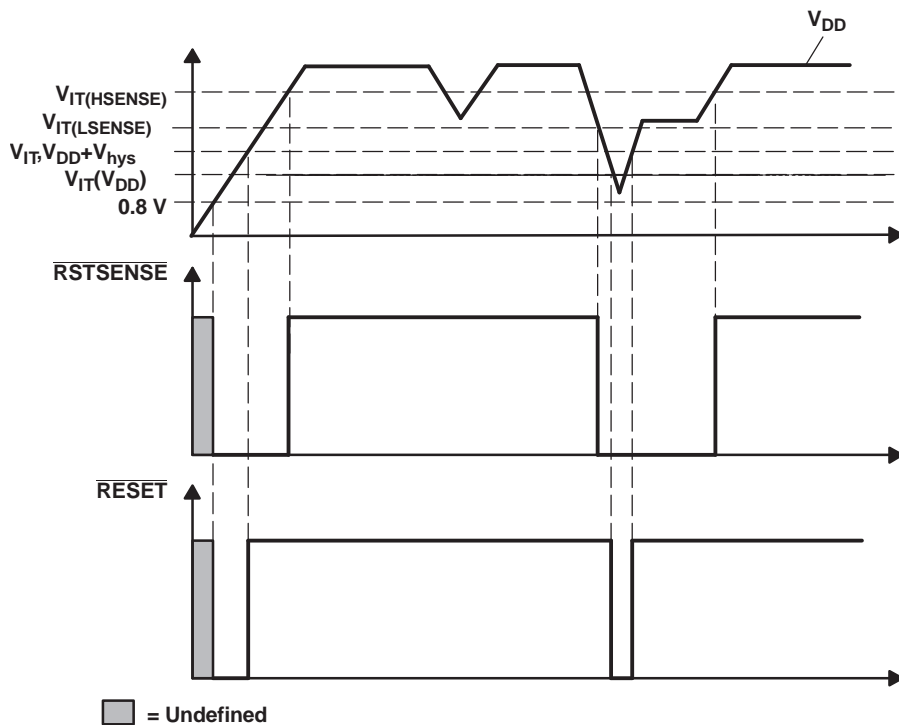

Table 2. TERMINAL FUNCTIONS

TERMINAL		I/O	DESCRIPTION
NAME	NO.		
GND	2	I	Ground
HSENSE	6	I	Adjustable hysteresis input
LSENSE	5	I	Adjustable sense input
$\overline{RESET}$	3	O	Active-low open-drain reset output (from $V_{DD}$ )
$\overline{RSTSENSE}$	1	O	Active-low open-drain reset output (from LSENSE)
$V_{DD}$	4	I	Input supply voltage and fixed sense input

FUNCTION AND TRUTH TABLE

TPS3806I33-Q1			
$V_{DD} > V_{IT}$	$\overline{RESET}$	$LSENSE > V_{IT}$	$\overline{RSTSENSE}$
0	L	0	L
1	H	1	H

### FUNCTIONAL BLOCK DIAGRAM

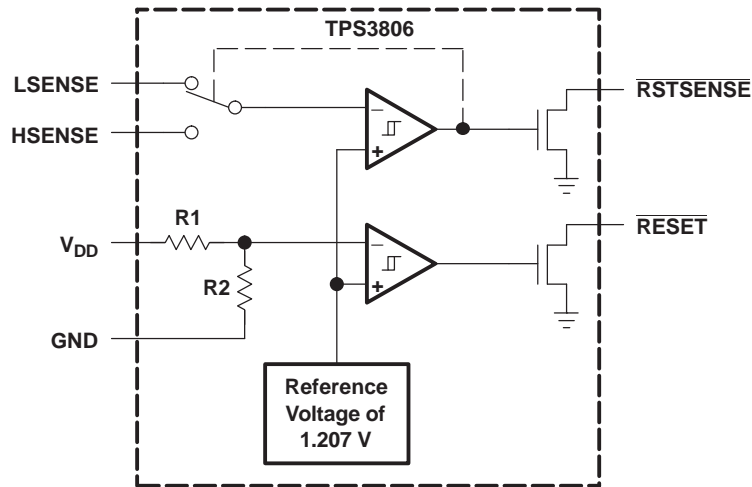

## Detailed Description

### Operation

The TPS3806I33-Q1 monitors battery voltage and asserts  $\overline{\text{RESET}}$  when a battery becomes discharged below a certain threshold voltage. A comparator monitors the battery voltage via an external resistor divider. When the voltage at the LSENSE input drops below the internal reference voltage, the  $\overline{\text{RSTSENSE}}$  output pulls low. The output remains low until the battery is replaced, or recharged above a second higher trip-point, set at HSENSE. One can monitor a second voltage at  $V_{\text{DD}}$ . The independent  $\overline{\text{RESET}}$  output pulls low when the voltage at  $V_{\text{DD}}$  drops below the fixed threshold voltage. Because the TPS3806I33-Q1 outputs are open-drain MOSFETs, most applications may require a pullup resistor.

### Programming the Threshold Voltage Levels

Calculate the low-voltage threshold at LSENSE according to [Equation 1](#):

$$V_{(\text{LSENSE})} = V_{\text{ref}} \left( \frac{R1 + R2 + R3}{R2 + R3} \right) \quad (1)$$

where  $V_{\text{ref}} = 1.207 \text{ V}$

Calculate the high-voltage threshold at HSENSE as shown in [Equation 2](#):

$$V_{(\text{HSENSE})} = V_{\text{ref}} \left( \frac{R1 + R2 + R3}{R3} \right) \quad (2)$$

where  $V_{\text{ref}} = 1.207 \text{ V}$

To minimize battery current draw, TI recommends using  $1 \text{ M}\Omega$  as the total resistor value  $R_{(\text{tot})}$ , with  $R_{(\text{tot})} = R1 + R2 + R3$ .

TYPICAL CHARACTERISTICS

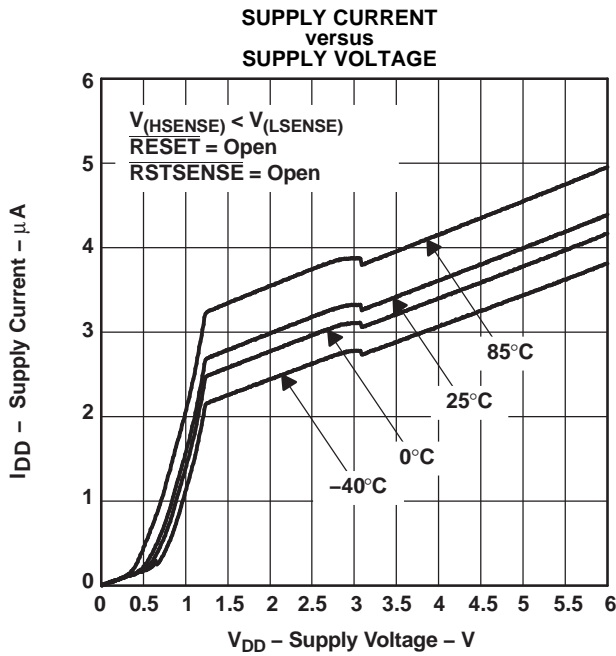

Figure 1.

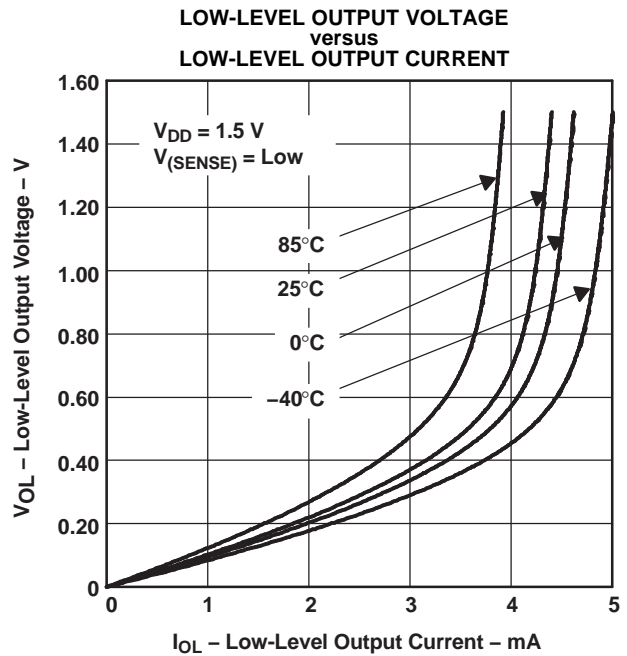

Figure 2.

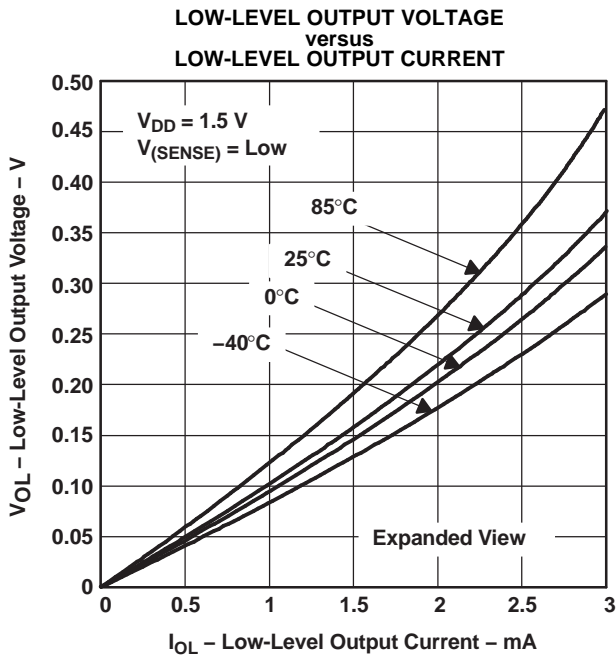

Figure 3.

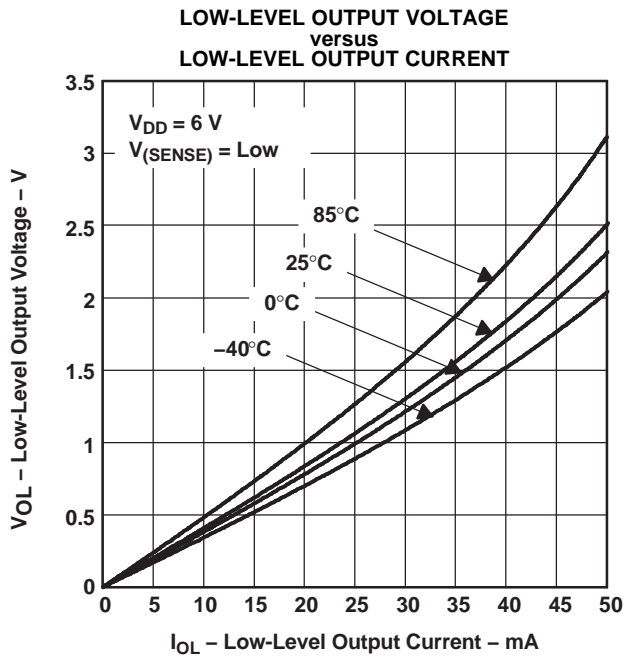

Figure 4.

**TYPICAL CHARACTERISTICS (continued)**

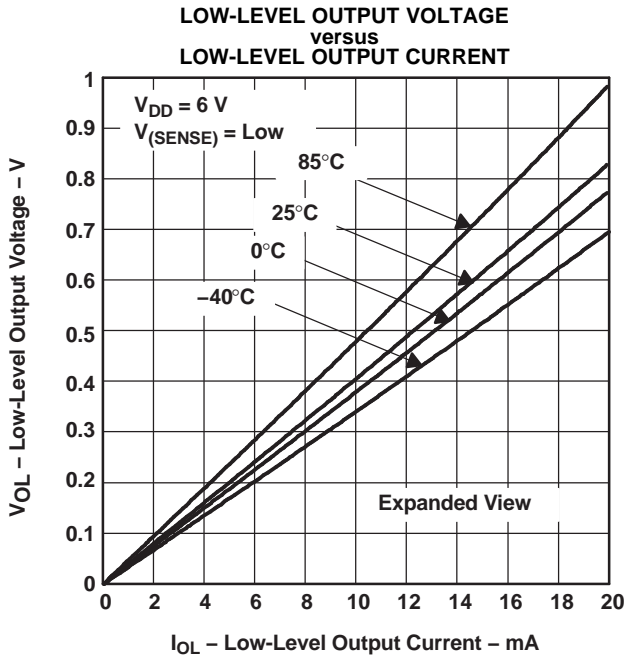

Figure 5.

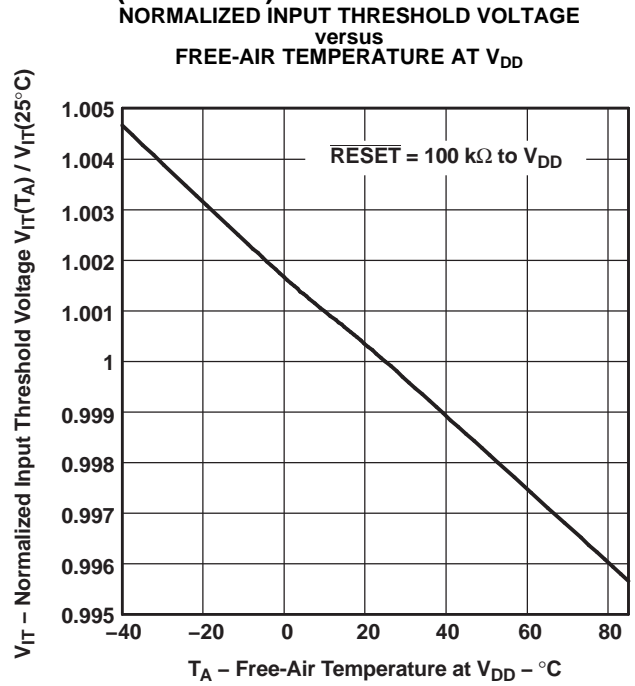

Figure 6.

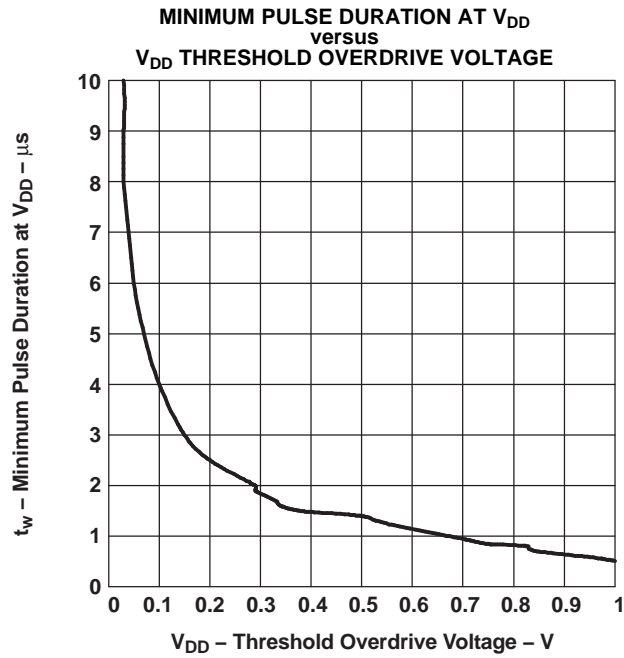

Figure 7.

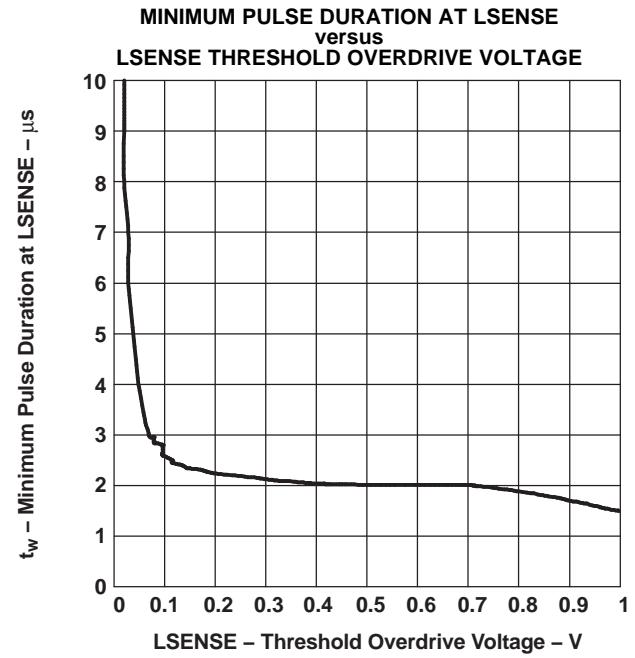

Figure 8.

**PACKAGING INFORMATION**

Orderable Device	Status (1)	Package Type	Package Drawing	Pins	Package Qty	Eco Plan (2)	Lead finish/ Ball material (6)	MSL Peak Temp (3)	Op Temp (°C)	Device Marking (4/5)	Samples
TPS3806I33QDBVRQ1	ACTIVE	SOT-23	DBV	6	3000	RoHS & Green	NIPDAU	Level-1-260C-UNLIM	-40 to 125	PZHQ	Samples

(1) The marketing status values are defined as follows:

**ACTIVE:** Product device recommended for new designs.

**LIFEBUY:** TI has announced that the device will be discontinued, and a lifetime-buy period is in effect.

**NRND:** Not recommended for new designs. Device is in production to support existing customers, but TI does not recommend using this part in a new design.

**PREVIEW:** Device has been announced but is not in production. Samples may or may not be available.

**OBSOLETE:** TI has discontinued the production of the device.

(2) **RoHS:** TI defines "RoHS" to mean semiconductor products that are compliant with the current EU RoHS requirements for all 10 RoHS substances, including the requirement that RoHS substance do not exceed 0.1% by weight in homogeneous materials. Where designed to be soldered at high temperatures, "RoHS" products are suitable for use in specified lead-free processes. TI may reference these types of products as "Pb-Free".

**RoHS Exempt:** TI defines "RoHS Exempt" to mean products that contain lead but are compliant with EU RoHS pursuant to a specific EU RoHS exemption.

**Green:** TI defines "Green" to mean the content of Chlorine (Cl) and Bromine (Br) based flame retardants meet JS709B low halogen requirements of <=1000ppm threshold. Antimony trioxide based flame retardants must also meet the <=1000ppm threshold requirement.

(3) MSL, Peak Temp. - The Moisture Sensitivity Level rating according to the JEDEC industry standard classifications, and peak solder temperature.

(4) There may be additional marking, which relates to the logo, the lot trace code information, or the environmental category on the device.

(5) Multiple Device Markings will be inside parentheses. Only one Device Marking contained in parentheses and separated by a "-" will appear on a device. If a line is indented then it is a continuation of the previous line and the two combined represent the entire Device Marking for that device.

(6) Lead finish/Ball material - Orderable Devices may have multiple material finish options. Finish options are separated by a vertical ruled line. Lead finish/Ball material values may wrap to two lines if the finish value exceeds the maximum column width.

**Important Information and Disclaimer:** The information provided on this page represents TI's knowledge and belief as of the date that it is provided. TI bases its knowledge and belief on information provided by third parties, and makes no representation or warranty as to the accuracy of such information. Efforts are underway to better integrate information from third parties. TI has taken and continues to take reasonable steps to provide representative and accurate information but may not have conducted destructive testing or chemical analysis on incoming materials and chemicals. TI and TI suppliers consider certain information to be proprietary, and thus CAS numbers and other limited information may not be available for release.

In no event shall TI's liability arising out of such information exceed the total purchase price of the TI part(s) at issue in this document sold by TI to Customer on an annual basis.

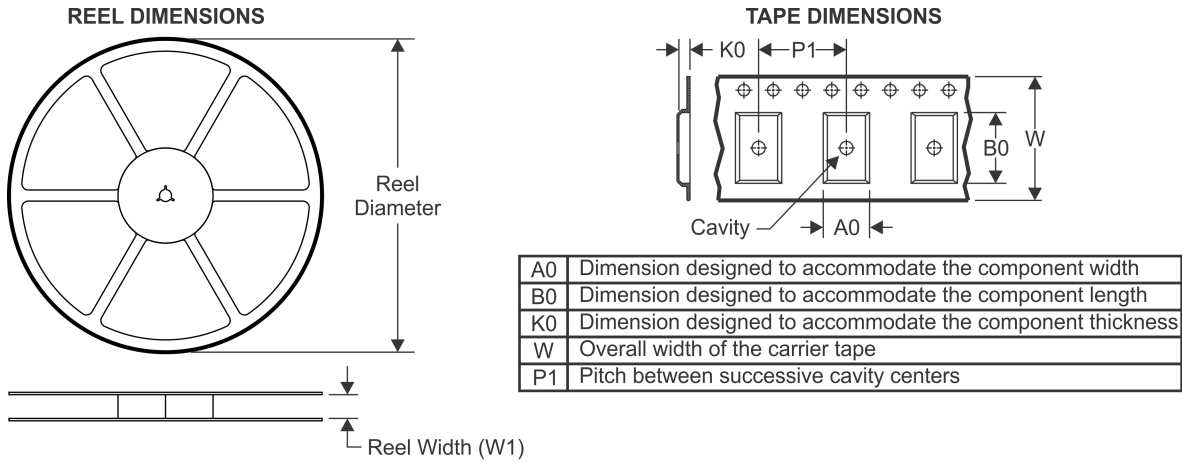
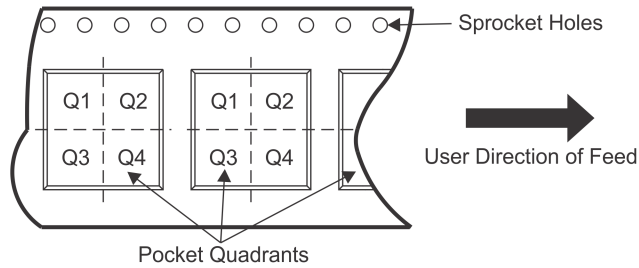
**TAPE AND REEL INFORMATION**

**QUADRANT ASSIGNMENTS FOR PIN 1 ORIENTATION IN TAPE**

\*All dimensions are nominal

Device	Package Type	Package Drawing	Pins	SPQ	Reel Diameter (mm)	Reel Width W1 (mm)	A0 (mm)	B0 (mm)	K0 (mm)	P1 (mm)	W (mm)	Pin1 Quadrant
TPS3806I33QDBVRQ1	SOT-23	DBV	6	3000	178.0	9.0	3.23	3.17	1.37	4.0	8.0	Q3

**TAPE AND REEL BOX DIMENSIONS**



\*All dimensions are nominal

Device	Package Type	Package Drawing	Pins	SPQ	Length (mm)	Width (mm)	Height (mm)
TPS3806I33QDBVRQ1	SOT-23	DBV	6	3000	180.0	180.0	18.0



# EXAMPLE BOARD LAYOUT

DBV0006A

SOT-23 - 1.45 mm max height

SMALL OUTLINE TRANSISTOR

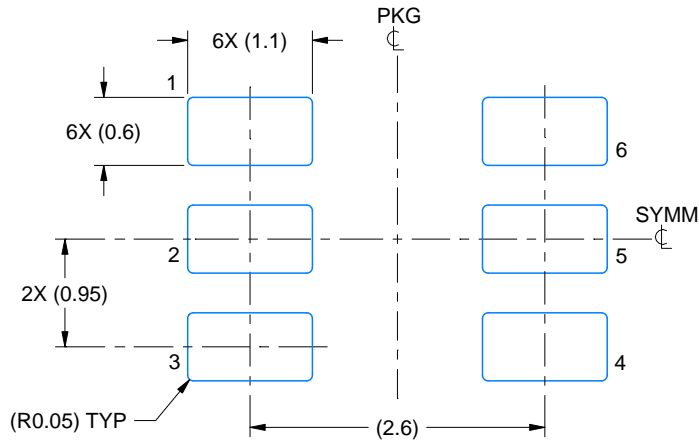

LAND PATTERN EXAMPLE  
EXPOSED METAL SHOWN  
SCALE:15X

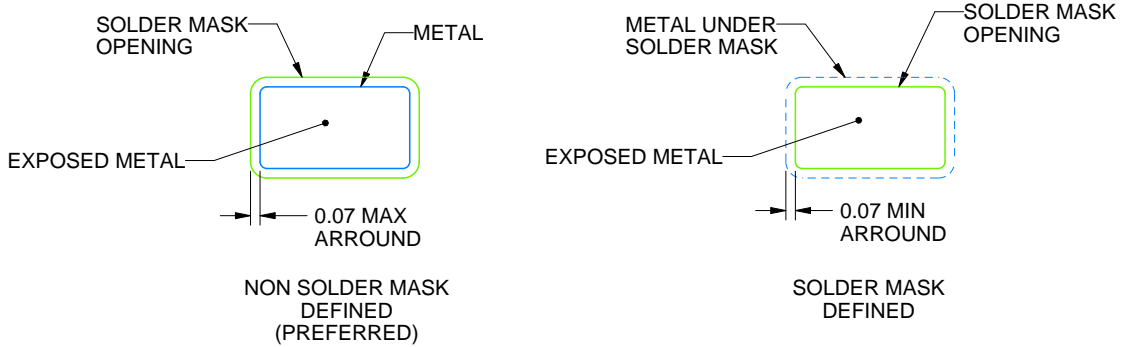

SOLDER MASK DETAILS

4214840/F 05/2024

NOTES: (continued)

- 6. Publication IPC-7351 may have alternate designs.
- 7. Solder mask tolerances between and around signal pads can vary based on board fabrication site.

# EXAMPLE STENCIL DESIGN

DBV0006A

SOT-23 - 1.45 mm max height

SMALL OUTLINE TRANSISTOR

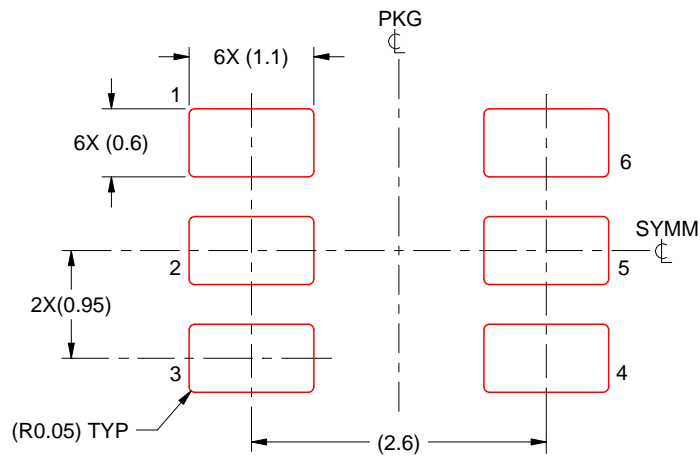

SOLDER PASTE EXAMPLE  
BASED ON 0.125 mm THICK STENCIL  
SCALE:15X

4214840/F 05/2024

NOTES: (continued)

8. Laser cutting apertures with trapezoidal walls and rounded corners may offer better paste release. IPC-7525 may have alternate design recommendations.
9. Board assembly site may have different recommendations for stencil design.

## IMPORTANT NOTICE AND DISCLAIMER

TI PROVIDES TECHNICAL AND RELIABILITY DATA (INCLUDING DATA SHEETS), DESIGN RESOURCES (INCLUDING REFERENCE DESIGNS), APPLICATION OR OTHER DESIGN ADVICE, WEB TOOLS, SAFETY INFORMATION, AND OTHER RESOURCES "AS IS" AND WITH ALL FAULTS, AND DISCLAIMS ALL WARRANTIES, EXPRESS AND IMPLIED, INCLUDING WITHOUT LIMITATION ANY IMPLIED WARRANTIES OF MERCHANTABILITY, FITNESS FOR A PARTICULAR PURPOSE OR NON-INFRINGEMENT OF THIRD PARTY INTELLECTUAL PROPERTY RIGHTS.

These resources are intended for skilled developers designing with TI products. You are solely responsible for (1) selecting the appropriate TI products for your application, (2) designing, validating and testing your application, and (3) ensuring your application meets applicable standards, and any other safety, security, regulatory or other requirements.

These resources are subject to change without notice. TI grants you permission to use these resources only for development of an application that uses the TI products described in the resource. Other reproduction and display of these resources is prohibited. No license is granted to any other TI intellectual property right or to any third party intellectual property right. TI disclaims responsibility for, and you will fully indemnify TI and its representatives against, any claims, damages, costs, losses, and liabilities arising out of your use of these resources.

TI's products are provided subject to [TI's Terms of Sale](#) or other applicable terms available either on [ti.com](https://www.ti.com) or provided in conjunction with such TI products. TI's provision of these resources does not expand or otherwise alter TI's applicable warranties or warranty disclaimers for TI products.

TI objects to and rejects any additional or different terms you may have proposed.

Mailing Address: Texas Instruments, Post Office Box 655303, Dallas, Texas 75265  
Copyright © 2024, Texas Instruments Incorporated